

USER MANUAL

GFK-2571V

Jan 2024

PACSystems™ RX3i and RSTi-EP PROFINET I/O-Controller

USER MANUAL



Contents

Section 1	Introduction.....	1
1.1	Revisions in this Manual.....	1
1.2	PROFINET Controller Description	3
1.2.1	PNC001 Description	4
1.2.2	Embedded PROFINET Controller.....	4
1.3	PNC001 Module Specifications.....	5
1.4	Operating Range for Surrounding Air Temperature.....	8
1.4.1	Operating Temperature De-Rating:	8
1.5	PNC001 Module Controls and Indicators.....	9
1.5.1	PNC001 Hardware Implementations (-Ax & -Bxxx).....	11
1.5.2	Ethernet Network Ports	12
1.5.3	USB Port(s).....	14
1.5.4	Reset Pushbutton.....	14
1.5.5	LEDs on the CPUs with Embedded PROFINET.....	14
1.5.6	LEDs on the PNC001 Module.....	14
1.6	PROFINET Networks for PACSystems.....	15
1.6.1	Compression	16
1.6.2	Basic System: One RX3i CPU and One PROFINET Controller using a single port.....	16
1.6.3	Basic System: One RX3i CPU and One PROFINET Controller using multiple ports	16
1.6.4	Basic System: Third-Party Devices and PAC Machine Edition Programmer	17
1.6.5	Systems with One RX3i CPU and Two PROFINET Controllers.....	18
1.6.6	One RX3i CPU with Four Controllers on Separate Networks.....	19
1.6.7	Two RX3i CPUs with Two PROFINET Networks and One Ethernet Network	20
1.6.8	Systems that use PROFINET System Redundancy (PNSR)	22
1.6.9	Systems that use Hot Standby CPU Redundancy.....	23
1.6.10	RSTi-EP Standalone CPU with embedded PROFINET Controller using a single port.....	23
1.6.11	RSTi-EP Standalone CPU with embedded PROFINET Controller using multiple ports.....	24
1.7	Glossary	26
1.8	Documentation	28

Section 2	Installation	30
2.1	Pre-Installation Check	30
2.2	Installation in Hazardous Areas	31
2.2.1	ATEX Marking	31
2.3	Removing the Backplane Knockout	31
2.4	Module Installation	31
2.5	Module Removal	32
2.6	Hot Insertion and Removal.....	33
2.7	Ethernet Port Connections	34
2.7.1	PROFINET Network Connections.....	34
2.7.2	RJ45 Port Connections	35
2.7.3	Installing SFP Devices	36
2.7.4	Removing SFP Devices	39
2.8	PNC001 LED Behavior.....	40
2.8.1	Power-up LED Patterns	40
2.8.2	Detailed LED Descriptions	41
2.9	Installing the USB Port Driver	44
2.10	Firmware Updates	45
2.10.1	PNC001 Firmware Updates	45
2.10.2	Firmware Updates for Embedded PROFINET	45
Section 3	Configuration.....	46
3.1	Configuration Overview	46
3.1.1	System Planning	47
3.1.2	Basic Configuration Steps.....	48
3.2	Configuration Tools	49
3.2.1	Non-Volatile Configuration Parameters	50
3.3	Configuring an RX3i PROFINET Controller	51
3.3.1	Configuring a Rack-Mounted RX3i PROFINET Controller (PNC001) ...	51
3.3.2	Configuring an Embedded RX3i PROFINET Controller	51
3.3.3	Configuring an Embedded RSTi-EP PROFINET Controller	52
3.4	Configuring PROFINET System Redundancy	53
3.5	Exploring PROFINET Networks	54
3.5.1	Configuring a PROFINET Controller on a LAN.....	55
3.5.2	Configuring PROFINET Controller Parameters	56
3.6	Configuring PROFINET LANs	60
3.6.1	Configuring the LAN Properties	61

3.7	Adding a VersaMax PROFINET Scanner to a LAN	63
3.7.1	Configuring VersaMax PROFINET Scanner Parameters	64
3.7.2	Adding VersaMax PROFINET Scanner Power Supplies	68
3.7.3	Adding VersaMax Modules to a Remote Node	69
3.7.4	Installing Power Supplies Between Modules	70
3.7.5	Configuring VersaMax Module Parameters	71
3.8	Adding a Third-Party IO-Device to a LAN	74
3.8.1	Editing Third-Party IO-Device Parameters	75
3.8.2	Configuring Sub-Modules of a Third-Party IO-Device	77
3.9	Viewing / Editing IO-Device Properties	79
3.10	Assigning IO-Device Names	80
3.11	After the Configuration is Stored to the RX3i CPU	82
Section 4	PROFINET System Operation.....	84
4.1	PROFINET Operation Overview	84
4.1.1	PROFINET Communications	85
4.2	Operations of the PROFINET Controller in the PACSystems System	87
4.2.1	Duplicate PROFINET IO-Device IP Address	88
4.2.2	Duplicate PROFINET IO-Controller IP Address	88
4.2.3	Resolving Duplicate IP Addresses	89
4.3	I/O Scanning	90
4.4	Data Coherency	91
4.5	Performance Factors	91
4.6	PROFINET IO Update Rate Configuration	91
4.7	PACSystems CPU Operations for PROFINET	92
4.7.1	Reference ID Variables for the PACSystems Application	92
4.7.2	PNIO_DEV_COMM Function Block	93
4.7.3	Reset Smart Module for the PROFINET Controller	95
4.7.4	DO I/O for Remote IO Modules	95
4.7.5	Scan Set I/O for Remote I/O Modules	95
4.7.6	PACSystems CPU Defaults - Inputs	96
4.7.7	PACSystems CPU Defaults - Outputs	96
Section 5	Diagnostics	97
5.1	Power-up and Reset (PNC001 Module)	97
5.1.1	Module Restart	97
5.1.2	Problems During Power-up and Reset	99
5.1.3	Transitioning to Firmware Update Mode	99

5.2	Special LED Blink Patterns	100
5.2.1	Special LED Pattern - Module Identification	100
5.2.2	Special LED Pattern - Microprocessor Overtemperature	100
5.2.3	Firmware Update.....	101
5.2.4	Internal Update.....	101
5.3	Status Reporting.....	101
5.4	I/O Fault Contacts	102
5.5	Fault Locating References	103
5.6	Fatal Error Reporting.....	103
5.7	PROFINET IO Alarms	103
5.8	Local Log Table of the PROFINET Controller.....	104
5.8.1	Faults Unique to Local Log Table	105
5.8.2	Viewing and Clearing the Local Log Table	108
5.9	PROFINET Controller Faults in the PACSystems Fault Tables.....	110
5.9.1	Clearing the PACSystems Fault Tables	110
5.9.2	Faults Reported to the PACSystems Controller Fault Table	110
5.9.3	Faults Reported to the PACSystems I/O Fault Table	111
5.9.4	PROFINET Fault Extra Data.....	128
Section 6	Redundant Media	131
6.1	PROFINET Media Redundancy Protocol.....	131
6.1.1	MRP Failover Performance.....	132
6.1.2	Bumpless Operation with MRP	133
6.1.3	MRP Operation for I/O Update Rates of 16ms or Greater.....	133
6.1.4	MRP Operation at I/O Update Rates Less Than 16ms.....	135
6.1.5	Minimum I/O Rate When Configured in an MRP Ring.....	135
6.1.6	Minimum I/O Update Rates for Bumpless Operation in an MRP Ring Topology	135
6.1.7	MRP Ring Ethernet Traffic Storm Prevention	138
6.1.8	Third-party MRP Manager Use with PROFINET Controller as MRP Client.....	138
6.2	Ring Topology with One Controller	140
6.3	Ring Topology with Multiple Controllers.....	140
6.4	Setting Up Media Redundancy Protocol	141
6.4.1	Media Redundancy Setup for a PROFINET Controller	141
6.5	Sequence for Enabling Media Redundancy.....	142
6.6	Sequence for Replacing a Media Redundancy Manager	143
6.7	Procedure for Disabling Media Redundancy	143

Section 7	Network Management.....	144
7.1	SNMP	144
7.1.1	Overview of SNMP.....	144
7.1.2	Supported SNMP Features	145
7.1.3	SNMP Read Access	146
7.1.4	SNMP Write Access.....	146
7.1.5	MIB-II Groups Supported	146
7.1.6	MIB-II System Group Values	148
7.2	LLDP.....	148
7.2.1	Overview of LLDP	148
7.2.2	LLDP Operation	149
7.2.3	LLDP TLVs.....	149
Appendix A:	PROFINET IO Performance Examples	153
A-1	Systems with RX3i PNS.....	154
A-1.1	RX3i System Descriptions	154
A-2	Systems with VersaMax PNS	154
A-2.1	VersaMax System Performance Summary.....	154
A-2.2	VersaMax System Descriptions	155
A-3	Systems with RSTi-EP EPSCPE100/CPE115.....	156
A-3.1	RSTi-EP CPE100/CPE115 Embedded PROFINET Controller System Performance Summary	156
A-3.2	RSTi-EP System Descriptions	157
A-4	Systems with RSTi-EP CPE200 Series	158
A-4.1	RSTi-EP CPE200 Series Embedded PROFINET Controller System Performance Summary	158
A-4.2	RSTi-EP CPE200 Series System Descriptions	159
	General Contact Information	161
	Technical Support.....	161

Warnings and Caution Notes as Used in this Publication

WARNING

Warning notices are used in this publication to emphasize that hazardous voltages, currents, temperatures, or other conditions that could cause personal injury exist in this equipment or may be associated with its use.

In situations where inattention could cause either personal injury or damage to equipment, a Warning notice is used.

CAUTION

Caution notices are used where equipment might be damaged if care is not taken.

Note: *Notes merely call attention to information that is especially significant to understanding and operating the equipment.*

These instructions do not purport to cover all details or variations in equipment, nor to provide for every possible contingency to be met during installation, operation, and maintenance. The information is supplied for informational purposes only, and Emerson makes no warranty as to the accuracy of the information included herein. Changes, modifications, and/or improvements to equipment and specifications are made periodically and these changes may or may not be reflected herein. It is understood that Emerson may make changes, modifications, or improvements to the equipment referenced herein or to the document itself at any time. This document is intended for trained personnel familiar with the Emerson products referenced herein.

Emerson may have patents or pending patent applications covering subject matter in this document. The furnishing of this document does not provide any license whatsoever to any of these patents.

Emerson provides the following document and the information included therein as-is and without warranty of any kind, expressed or implied, including but not limited to any implied statutory warranty of merchantability or fitness for particular purpose.

Section 1 Introduction

This Section introduces the PACSystems RX3i & RSTi-EP PROFINET system and describes the various forms of RX3i & RSTi-EP PROFINET Controllers:

1. The IC695PNC001 module (abbreviated PNC001), which is a rack-mounted module residing in the CPU Rack; there are two hardware versions of this module: IC695PNC001-Ax and IC695PNC001-Bxxx. The differences are explained in Section 1.5.
2. The embedded PROFINET Controllers available in certain RX3i & RSTi-EP CPUs. At publication, the IC695CPL410 (CPL410), IC695CPE400 (CPE400), IC695CPE330 (CPE330), EPXCPE205/210/215/220/240 and EPSCPE100/EPSCPE115 (CPE100/CPE115) permit LAN2 to be configured as a PROFINET Controller.

The last two pages of this Section are a glossary that summarizes many terms used in the manual.

Section 2 Installation explains how to install a PNC001, how to complete port connections, and how to update the PNC001 module firmware. Section 2 also explains how to install the USB port driver on the PNC001 module (PNC001-Ax only) and describes how the module synchronizes its internal clock with the RX3i CPU. Since embedded PROFINET Controllers require no installation *per se*, refer to the installation instructions for the corresponding PLC CPU.

Section 3 Configuration explains how to complete and download the PACSystems RX3i & RSTi-EP configuration for target PROFINET Controller, as well as devices present on the associated PROFINET network. The associated devices typically include RX3i and VersaMax PROFINET Scanners and third-party PROFINET devices but may also include additional PROFINET Controllers present on the network.

Section 4 PROFINET System Operation describes I/O scan operation and application program function blocks for use with any RX3i & RSTi-EP PROFINET Controller (slot-mounted or embedded). This Section also provides an overview of PROFINET communications between the controller and IO-Devices.

Section 5 Diagnostics

explains the power-up and reset process, special LED blink patterns, status reporting, and fatal error reporting. It also describes faults and corrective actions.

Section 6 Redundant Media, explains how a PROFINET system can be set up for PROFINET Media Redundancy Protocol (MRP), and describes ring topologies that might be used.

Section 7 Network Management explains the use of SNMP (Simple Network Management Protocol) and Link Layer Discovery Protocol (LLDP) to assist network management. These features are available in PNC001 firmware version 1.10 or later, and in all firmware versions of CPL410, CPE400, CPE330, CPE205/210/215/220/240 and CPE100/CPE115.

1.1 Revisions in this Manual

Rev	Date	Description
V	Jan 2024	Update to IC695PNC-Bxxx LED usage for DCP Pattern on IC695PNC001-Bxxx. Section 5.2.1.
U	Nov 2022	Updates to support RSTi-EP Backplane controllers (CPE200 Series) release. Added Section 5.9.4, PROFINET Fault Extra Data.

Rev	Date	Description
T	Aug 2022	Additional updates to support RSTi-EP Backplane controllers (CPE200 Series) release.
R	Apr 2021	Updates regarding the number of supported PROFINET devices for the CPL410. Updates to Sections 0 and 0 to clarify that the PNC001-Bxxx is a drop-in replacement.
Q	Sep 2019	Following Emerson's acquisition of this product, changes have been made to apply appropriate branding and registration of the product with required certification agencies. No changes to material, process, form, fit or functionality.
P	Jul 2018	Updated for IC695CPL410 (new CPU with Linux) Updated for IC695PNS101 (Advanced PROFINET Scanner module)
N	May 2018	Corrected the units associated with Network Transit Time, which is a millisecond. Clarification added for footnote 3. Added introductory section on PROFINET System Redundancy (Section 1.6.8). Added a note on Compression at Section 1.6.1.
M	Apr 2018	Added information about embedded PROFINET Controllers in RSTi-EP CPU CPE115 module
L	Feb 2018	Compatibility with CPE302.
K	Dec-2017	Updates for new hardware version, IC695PNC001-Bxxx.
J	Oct-2017	Updated content for CPE400. Added Section 3.4, Configuring PROFINET System Redundancy Correction made in Section 4.2.2, Duplicate PROFINET IO-Controller IP Address.
H	Aug-2017	Added MRP information for embedded PROFINET Controllers in RSTi-EP CPU EPSCPE100 (CPE100).
G	Apr-2017	Added information about embedded PROFINET Controllers in RSTi-EP CPU EPSCPE100 (CPE100) Noted max loading and performance differences between embedded and rack-mounted PROFINET controllers.
F	Dec-2016	Added information about embedded PROFINET Controllers in CPE400 and CPE330 Noted max loading and performance differences between embedded and rack-mounted PROFINET controllers.
E	Mar-2015	PNC001 Module Specifications section updated to include CPE305, CPE310 and CPE330

Rev	Date	Description
D	Nov-2014	<p>Added/modified information to include critical network port feature.</p> <p>Increased maximum I/O-device support from 64 to 128 devices per PNC001 (star topology).</p> <p>Increased maximum redundant I/O-device support from 128 to 255 for the system.</p> <p>In section 5.9.2.Faults Reported to the PACSystems Controller Fault Table, added new Controller Fault description for Unable to deliver configuration to module fault.</p> <p>In section 5.9.3 Faults Reported to the PACSystems I/O Fault Table, changed details about PROFINET Controller Heavily Loaded and Loading has Improved faults.</p> <p>In section 6.1 PROFINET Media Redundancy Protocol, Added additional MRP performance information (table from the PUN, and new information).</p> <p>In sections 0</p> <p>SNMP Read Access and 7.1.4 SNMP Write Access, Changed PROFINET Controller SNMP access credentials and capabilities to reflect differences between firmware versions 2.05 or earlier and 2.10 or later.</p>
C	Mar-2014	<p>Section 1, Introduction: made edits to clarify that products other than VersaMax support redundancy.</p> <p>Section 4, PROFINET System Operation: made edits to support redundancy.</p> <p>Section 6, Redundant Media: added table to show which PROFINET Scanner/Device supports PROFINET Media Redundancy Protocol (MRP), and made other edits to clarify that products other than VersaMax support redundancy.</p>

1.2 PROFINET Controller Description

This manual covers three types of PROFINET Controllers:

1. The traditional Rack-mounted RX3i PROFINET Controller: IC695PNC001;
2. A PROFINET Controller that is embedded within a CPU:
 - a. *Standalone*: RX3i IC695CPL410 and IC695CPE400; RSTi-EP EPSCPE100, EPSCPE115
 - b. *Backplane Controller*: RSTi-EP EPXCPE205, EPXCPE210, EPXCPE215, EPXCPE220, EPXCPE240; RX3i IC695CPE330

1.2.1 PNC001 Description

The PACSystems RX3i PROFINET Controller module, IC695PNC001, connects a PACSystems RX3i controller to a PROFINET network. It enables the RX3i controller to communicate with IO-Devices on the network. The PNC001 provides all the functions, services, and protocols required for certification as a PROFINET IO Version 2.2 IO Controller, running at both 100Mbps and 1Gbps.

The PNC001 supports 10/100/1000Mbps Copper, 100/1000Mbps Multi-mode Fiber, and 100/1000Mbps Single-mode Fiber. The network can include media interfaces of more than one type. PROFINET communications on the network require 100 and 1000 Mbps link speed. 10Mbps cannot be used for PROFINET communications. However, 10Mbps can be used for other types of Ethernet traffic, such as ping, and telnet.

Features of the RX3i PNC001 module include:

- Full programming and configuration services for the PROFINET Controller, PROFINET Scanners (PNS), and other third-party IO-Devices using PAC Machine Edition.
- Firmware upgrades using the WinLoader software utility.
- Built-in Command Line Interface function that provides direct monitoring and partial configuration via the module's micro USB port or using telnet (PNC001-Ax only).

Note: The USB port is for system set-up and diagnostics only. It is not intended for permanent connection.

- Support for star, ring, and daisy-chain/line network topologies.
- Four switched Ethernet ports — two 8-conductor RJ45 shielded twisted pair 10/100/1000 Mbps copper interfaces and two Small Form-factor Pluggable (SFP) cages for user-supplied SFP devices.
- Support for media redundancy
- Internal clock synchronized with the RX3i CPU for time-stamped diagnostics entries.
- Restart pushbutton to manually restart the module without power cycling the system.
- LEDs: OK, LAN, STATUS, CONFIG, ACTIVE, USB (PNC001-Ax only), and Port Number LEDs as shown in Figure 2 and Figure 3.

1.2.2 Embedded PROFINET Controller

CPL410, CPE400, CPE330, CPE205/210/215/220/240 and CPE100/CPE115 feature an Embedded PROFINET IO-Controller function. This feature permits LAN2 to be configured as a PROFINET Controller like PNC001 in functionality, but without requiring the presence of a PNC001 rack-mounted module.

Figure 1: IC695PNC001-Bxxx Front View

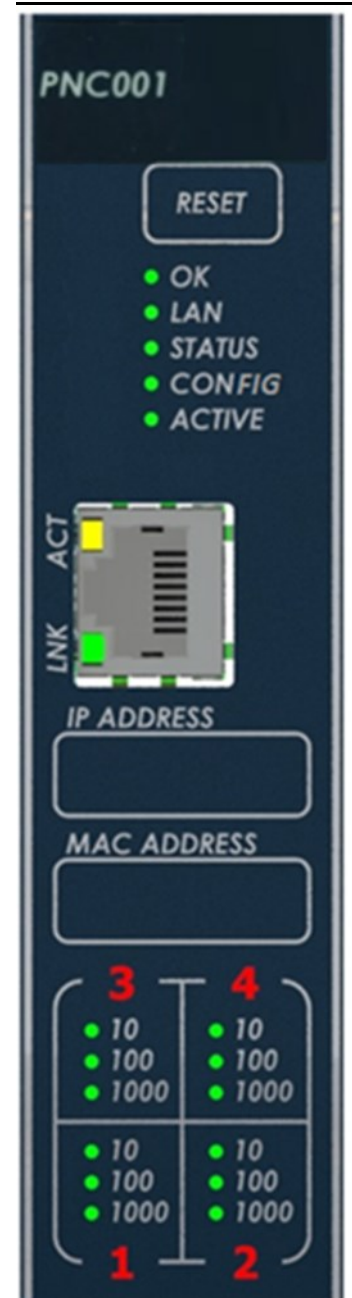

In the following Specifications section, the physical specifications related to rack mounting do not apply to the embedded PROFINET Controllers. Refer to the corresponding product documentation for CPL410, CPE400, CPE330, CPE205/210/215/220/240 and CPE100/CPE115 in the PACSystems RX7i, RX3i and RSTi-EP CPU Reference Manual, (GFK-2222AE or later).

1.3 PNC001 Module Specifications

Specification	Description	
PROFINET Support	PROFINET Version 2.2 General Class A IO-Controller Redundantly controlled operation conforms to PROFINET V2.3 Type S-2 System Redundancy. Note that the CPE205/210/215/220/240 and CPE100/CPE115 are simplex PROFINET IO-Controllers.	
CPU Compatibility	Requires CPU315, CPU320, CPE305, CPE310 or CPE330 with firmware version 7.0 or higher. Also compatible with all versions of CPE302. Simplex or redundantly-controlled PROFINET I/O requires CRU320 release 8.00 or higher. For the current status of CPE330 features refer to <i>PACSystems RX7i, RX3i and RSTi-EP CPU Reference Manual</i> , (GFK-2222Z or later). Note that CPL410, CPE400, CPE205/210/215/220/240 and CPE100/CPE115 feature embedded PROFINET IO-Controllers; these are standalone CPUs and do not support IC695PNC001.	
Power Requirements ¹ ,	Rev. -Ax:	Rev. -Bxxx:
with no SFP devices installed	3.3Vdc: 0.5A	3.3Vdc: 0.5A
with two SFP devices installed, 0.35A per SFP	3.3Vdc: 1.2A maximum	3.3Vdc: 1.2A maximum
	5 Vdc: 1.5A maximum	5 Vdc: 0.75A maximum
Operating Temperature Range ¹	Rev. -Axxx: 0°C to 60°C	Rev. -Bxxx: -25°C to 60°C
	Note: See Section 1.4 for de-rating conditions	
Number of PROFINET Port Connectors ¹	PNC001 –2 RJ45 and 2 SFP Cages located on the underside of module (SFP devices not included, available separately). Embedded PROFINET IO-Controller – 2 RJ45.	
Front Panel Connectors ¹	PNC001-Ax: One micro USB for communication with a computer using Command Line Interface. PNC001-Bxxx: One RJ45. Disabled.	
Command Line Interface Supported	PNC001-Ax – Yes. PNC001-Bxxx: No. Embedded PROFINET IO-Controller – No.	

¹ For CPE400, CPE330 and CPE100, CPE115 refer to the equivalent product specifications in the PACSystems RX7i, RX3i and RSTi-EP CPU Reference Manual, (GFK-2222Z or later).

Specification	Description
LAN ¹	IEEE 802.2 Logical Link Control Class I IEEE 802.3 CSMA/CD Medium Access Control 10/100/1000 Mbps
Maximum I/O Memory	128 Kbytes of combined input/output memory per PROFINET Controller Note: <i>RSTi-EP CPE100/CPE115 supports a maximum of 8 IO Devices. The combined input and output memory are equivalent to the input /output memory requirements of those 8 devices.</i>
Hot-swappable	PNC001 – Yes; Embedded PROFINET IO-Controller – No.
CPU Status Bits	32
PROFINET IO-Device Data Update Rates on the PROFINET Network	Configurable: 1ms, 2ms, 4ms, 8ms, 16ms, 32ms, 64ms, 128ms, 256ms and 512ms Note: <i>For CPE100/CPE115, Update Rates below 16ms are not recommended.</i>
Number of IP Addresses	One
Number of MAC Addresses	PNC001 – 5. One per external PROFINET port and one internal. Embedded PROFINET IO-Controller – 1.
System Maximum Limits	
PROFINET Controllers per RX3i CPU	Four PNC001 maximum. Must be in main CPU rack. Cannot be in a remote node. CPE330 supports one embedded PROFINET Controller plus up to four PNC001. CPL410, CPE400, CPE205/210/215/220/240 & CPE100/CPE115 support one embedded PROFINET Controller. Since these are standalone CPUs, they do not support any PNC001 in their hardware configuration.
Max IO-Devices per IO-Controller (at the maximum update rate interval, 16ms to 256ms)	PNC001 – 128 CPE330/CPE400 – 32 (simplex) or 20 (Hot Standby Redundancy) CPL410 – 64 (simplex) or 32 (Hot Standby Redundancy) CPE205 - 8 CPE210/215 - 16 CPE220/240 - 32 RSTi-EP CPE100/CPE115 – 8 For limits at shorter update intervals, refer to PROFINET Controller Loading Limits in Section 3.

Specification	Description
Max MRP Clients when configured as MRP Manager	Embedded PROFINET Controller PNC001 – 63 Embedded PROFINET Controller CPE330/CPE400 – 31 Embedded PROFINET Controller CPL410 – 63 Embedded PROFINET Controller CPE205 - 7 Embedded PROFINET Controller CPE210/215 - 15 Embedded PROFINET Controller CPE220/240 - 31 Embedded PROFINET Controller CPE100/CPE115 ² – 8
IO-Devices per Network	Maximum of 255 simplex or 255 redundant I/O Devices per network, spread across a maximum of 8 I/O Controllers. The actual total number of devices supported per network depends on the topology. For details, refer to Maximum Number of Nodes per Network based on Topology, below.
IO-Devices per RX3i CPU	Maximum of 255 simplex or 255 redundant I/O Devices per RX3i CPU, spread across up to four PROFINET Controllers. ³
IO-Devices per RSTi-EP CPU	Maximum of 8 simplex I/O Devices for CPE205 Maximum of 16 simplex I/O Devices for CPE210/215 Maximum of 32 simplex I/O Devices for CPE220/240 Maximum of 8 simplex I/O Devices for CPE100/CPE115
IO-Controllers per Network	Eight maximum
Input and output memory per IO-Controller	Maximum of 128 Kbytes combined input and output memory Note: RSTi-EP CPE100/CPE115 supports maximum 8 IO Devices so the combined input and output memory is equivalent to maximum input /output memory supported by 8 devices.
Number of PROFINET Slots per device	256
Number of PROFINET Sublots per slot	256
Number of PROFINET Submodules per RX3i CPU	2048
Programmer Limits	
Number of IO-Controllers	128 (32 RX3i CPU targets × 4 IO-Controllers per RX3i CPU)
Number of IO-Devices	2048 (128 per network × 16 PROFINET networks)
Total number of devices	2176 (does not include backplanes, power supplies, or I/O modules)

For product standards, general operating specifications, and installation requirements, refer to the PACSystems RX3i System Manual, GFK-2314.

² Effective with firmware v9.30, CPE100/CPE115 supports MRP.

³ In the case of CPE330, with embedded PROFINET activated, it is possible to have five PROFINET Controllers. However, in the rare case of having all 5 PNCs configured on the same LAN, and then invoking redundancy, each CPU is again restricted to a limit of 4 PNCs (in order to satisfy the overall limit of 8 PNCs per LAN).

Maximum Number of Nodes per Network based on Topology

- For a network using MRP ring topology, the maximum number of nodes is 64 (consisting of the PNC001 PROFINET Controller(s) plus up to 62 or 63 IO-Devices). If the ring uses Media Redundancy Protocol, this means one Media Redundancy Manager and up to 63 clients.
- For a network using MRP ring topology and an Embedded PROFINET IO-Controller as the MRP Ring Manager, the maximum number of nodes is
 - for CPE330/CPE400: 32 (1 MRP Manager and 31 MRP clients)
 - for CPL410: 64 (1 MRP Manager and 63 MRP clients)
 - for CPE205: 8 (1 MRP Manager and 7 MRP clients)
 - for CPE210/215: 16 (1 MRP Manager and 15 MRP clients)
 - for CPE220/240: 32 (1 MRP Manager and 31 MRP clients)
 - for CPE100/CPE115: 9 (1 MRP Manager and 8 MRP clients).
- For a network using star topology, the maximum number of nodes configurable is 263 (consisting of up to 8 PNC001 PROFINET Controllers plus up to 255 IO-Devices).
- For a network using star, line topology, or MRP Ring (where the Embedded PROFINET IO-Controller is not the MRP Ring Manager) the maximum number of nodes configurable of the system is 264. This may consist of up to eight IC695PNC001 PROFINET Controllers and one Embedded PROFINET IO-Controller (CPL410, CPE400 or CPE330) plus up to 255 I/O-Devices.

1.4 Operating Range for Surrounding Air Temperature

PNC001-AX	0 to 60°C surrounding air temperature
PNC001-BXXX	-25 to 60°C surrounding air temperature

1.4.1 Operating Temperature De-Rating:

The operating temperature range is specified for the module and not the system. As a guideline, if the module is next to hot neighbor modules on each side, the maximum operating ambient temperature should be de-rated as described below:

- If 100 MB Fiber SFPs installed, then reduce by 5°C
- If Copper SFPs operating at 1 GB, then reduce by 6°C

1.5 PNC001 Module Controls and Indicators

Figure 2: IC695PNC001-Ax Controls & Indicators

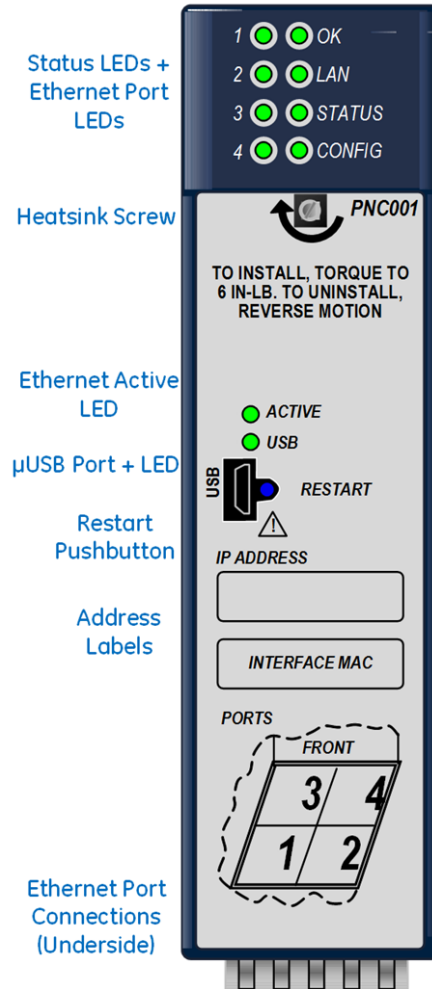
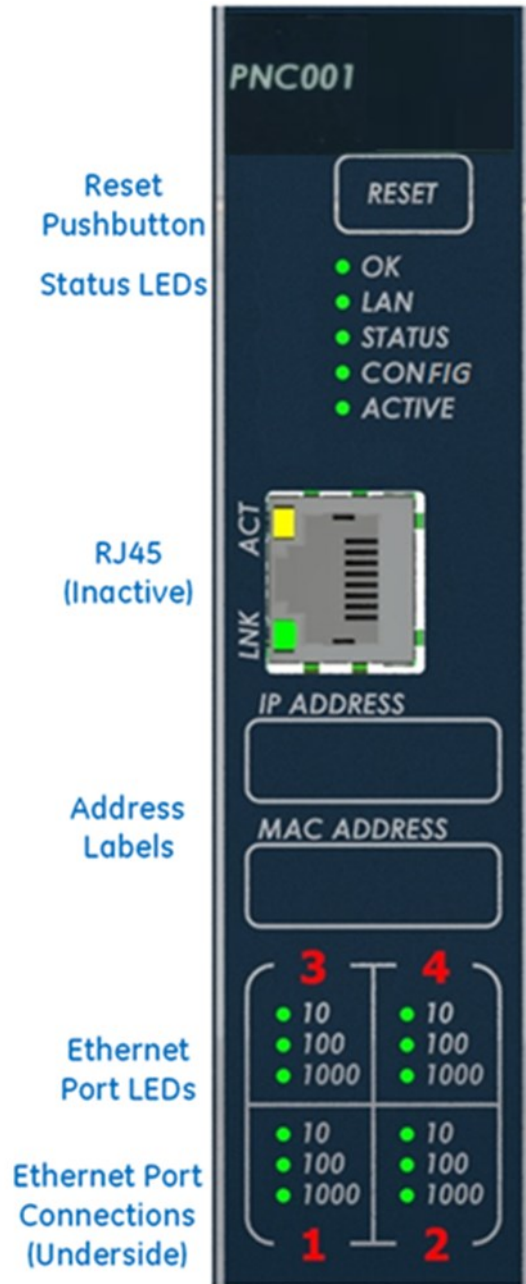

Figure 3: IC695PNC001-Bxxx Controls & Indicators



1.5.1 PNC001 Hardware Implementations (-Ax & -Bxxx)

In January 2018, an updated hardware implementation (-Bxxx) replaced the earlier version (-Ax) of the rack-mounted PNC001. The PNC001-Bxxx is a drop-in replacement for the PNC001-Ax.

The following are the differences between these two hardware implementations:

Topic	-Ax	-Bxxx
Appearance	Figure 2	Figure 3
Case	Plastic	Metal
Attachment to Rack	Via plastic case latch and heatsink screw	Via two Phillip's head machine screws
Heatsink	Remove plastic knockout from rack	No knockout removal required
Status LEDs	6 LEDs	5 LEDs (no USB LED)
LED Behavior	See Section 2.8	See Section 2.8
Ethernet Port LEDs	4 singleton LEDs (top of faceplate)	4 banks of LEDs (bottom of faceplate) The digits representing the port numbers are backlit by LEDs.
µUSB Port	Present	Absent
Command Line Interface	Uses Micro USB Port	Not available
RJ45 Connector on Faceplate	Absent	Present (Disabled)
Power Requirements	Higher (see Section 1.3)	Lower (see Section 1.3)
Operating Temperature Range (Surrounding Air)	0 to 60°C	-25 to 60°C
Module Reset	Pushbutton "Restart"	Membrane "Reset"

With the Exception for the Command Line Interface, the -Bxxx version is functionally compatible with the -Ax version.

1.5.2 Ethernet Network Ports

Figure 4 shows the underside of the PNC001 module.

- Ports 1 and 2 are standard RJ45 connections.
- Ports 3 and 4 offer Small Form-factor Pluggable (SFP) cages

The PROFINET Controller connects to a PROFINET network via one or more of its four external switch ports. Two 8-conductor RJ45 shielded twisted pair 10/100/1000 Mbps copper interfaces and two SFP cages provide flexibility in media selection and the ability to use redundant media for the PROFINET network. Use of redundant media must first be set up in the module configuration. Section 6 provides additional information about Redundant Media.

The PROFINET protocol supported by the PACSystems RX3i PROFINET modules can be sent and received over any of the four external ports on PNC001.

The PNC001 module is assigned five Ethernet MAC addresses: one for each of the four external Ethernet ports and one for the internal switch.

Figure 4: PNC001 Ethernet Ports Location and Type

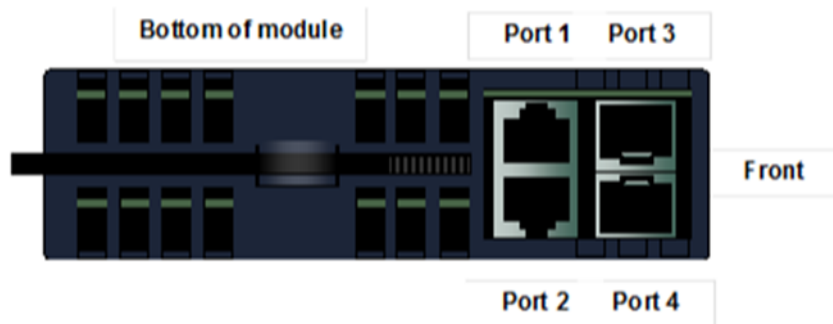

For the Embedded PROFINET LAN (LAN2), CPL410, CPE400, and CPE330 provide two RJ45 ports identical to those shown as Port 1 and Port 2 in Figure 4. The operational behavior, configuration parameters, and diagnostics are also identical. Refer to the corresponding product documentation for further details.

Small Form-factor Pluggable (SFP) cages (like Port 3 and Port 4 in Figure 4) are not offered on CPL410, CPE400, CPE330, CPE205/210/215/220/240, and CPE100/CPE115.

Figure 5: CPE100/CPE115 Ethernet Ports Location and Type

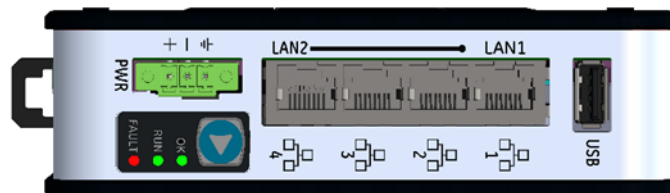

The CPE100/CPE115 Embedded PROFINET LAN (LAN2) supports three switched 8-conductor RJ45 shielded twisted pair 10/100 Mbps copper interfaces ports as shown in Figure 5. The operational behavior, configuration parameters, and diagnostics are identical to the PROFINET port of CPE400. Refer to the corresponding product documentation for further details.

CPE100/CPE115 LAN2 Port 2 and Port 3 can use redundant media for the PROFINET network. Use of redundant media must first be set up in the module configuration. Section 6 provides additional information about Redundant Media.

Figure 6: CPE200 Ethernet Ports Location and Type

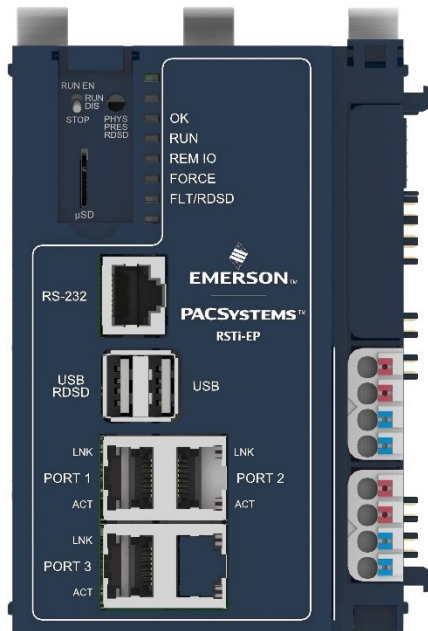

The CPE205 controller can be configured for Single LAN mode or Dual LAN mode (The default operating mode is Dual LAN mode). The CPE205 only supports PROFINET MRP in Single LAN mode.

The CPE210/215/220/240 controllers support PROFINET on Lan 2 (Ports 1 and 2). LAN 1 does not support PROFINET communication.

Ethernet Port Status Indicators

Each external switched port has an associated link-up/link-down status bit that can be monitored by the RX3i CPU to check the operating status of the port (see Status Reporting in Section 5 Diagnostics

for information about the PROFINET Controller status bits). In addition, the *Port Number* LEDs on the front of the module provide a visual indication of the port status.

1.5.3 USB Port(s)

The USB ports on the CPUs that support embedded PROFINET operate independently of the PROFINET function. Refer to the corresponding product documentation for further details.

The PNC001-Bxxx module has no micro USB port, and therefore does not support the Command Line Interface.

The PNC001-Ax module has a micro USB port for connection to a computer running Windows® 2000, Windows XP, Windows Vista®, Windows 7 or Windows 10. On the PNC001 module (-Ax version) only, the USB port can be used to access the Command Line Interface (CLI) function using a terminal emulation application such as HyperTerminal.

The Command Line Interface function can be used to monitor a PROFINET Controller module and check its operation. If a problem occurs, the Command Line Interface can be used help determine the cause.

A driver-install application is provided to set up a computer to communicate with the USB port (see Section 2 Installation, for instructions).

1.5.4 Reset Pushbutton

The Reset pushbutton on a PNC001 module can be used to manually reset the module without cycling power. The restart operation commences when the pushbutton is released.

1.5.5 LEDs on the CPUs with Embedded PROFINET

Refer to the corresponding product documentation for further details.

1.5.6 LEDs on the PNC001 Module

The table below summarizes LED functions on the PNC001 module. More detailed information about error indications and special blink patterns is given in Section 2 Installation and Section 5 Diagnostics

OK	Green ON indicates that the module can perform normal operation.
LAN	Indicates network packets are being processed by the network interface (not just passing through the embedded switch).
STATUS	Indicates the condition of the PROFINET Controller during normal operation. It indicates whether an entry other than the start-up event is present in the module's Local Log. STATUS can also indicate whether any of the MAC addresses are invalid.
CONFIG	Indicates whether the module has received its configuration from the RX3i CPU.
ACTIVE	Indicates the status of PROFINET connections.
USB	Indicates activity on the USB port. (PNC001-Ax only)
Port LEDs	Indicate link speed, link connection and link activity corresponding to the four possible external Ethernet ports.

1.6 PROFINET Networks for PACSystems

PROFINET is an open standard for industrial automation that is based on Industrial Ethernet. The PROFINET IO framework allows the creation of I/O data exchanges between controllers and distributed devices. It also allows configuration, parameterization, and diagnostics communication between controllers and devices.

Note: *The PROFINET Controller operates only in auto-negotiate mode. All PROFINET bus devices and switches that are connected to the PROFINET Controller should be configured to use auto-negotiation.*

The following products support PROFINET I/O:

Catalog #	Product	Notes
IC695CPE400 IC695CPE410	RX3i Rackless CPU with embedded PROFINET Controller	LAN2 may be configured as PROFINET Controller
IC695CPE330	RX3i CPU with embedded PROFINET Controller	LAN2 may be configured as PROFINET Controller Supports up to 4 PNC001 in its rack
IC695CPUxxx	All other RX3i CPUs without Redundancy	Supports up to 4 PNC001 in its rack
IC695CRUxxx	All other RX3i CPUs with Redundancy	Supports up to 4 PNC001 in its rack
IC695PNC001	RX3i Rack-Mounted PROFINET Controller	Controls IO-Devices on PROFINET network
IC695PNS001 IC695PNS101	RX3i Rack-Mounted PROFINET Scanner	Head-End for RX3i I/O Rack. Exchanges I/O data and Alarms with PROFINET Controller. Scans modules installed in its I/O Rack.
IC695CEP001	RX3i CEP I/O Drop PROFINET Scanner	Head-End for RX3i CEP I/O Drop. Exchanges I/O data and Alarms with PROFINET Controller. Scans modules installed in its backplane and expansion rack.
IC200PNS001 IC200PNS002	VersaMax PROFINET Scanner	Head-End for VersaMax I/O Rack. Exchanges I/O data and Alarms with PROFINET Controller. Scans modules installed in its I/O Rack.
EPXCPE205/210/215/220/240	RSTi-EP Backplane CPU with embedded PROFINET Controller	LAN2 may be configured as PROFINET Controller
EPSCPE100/CPE115	RSTi-EP Standalone CPU with embedded PROFINET Controller	LAN2 may be configured as PROFINET Controller
EPXPNS001/EPXPNS101	RSTi-EP PROFINET Scanner	Head-End for RSTi-EP I/O system. Exchanges I/O data and Alarms with PROFINET Controller. Scans modules installed in its I/O system.

Components of the RX3i PROFINET network consist of a PACSystems RX3i PROFINET Controller communicating with IO Devices on the PROFINET bus.

The PROFINET Controller may be an embedded PROFINET Controller (CPL410, CPE400 or CPE330, CPE205/210/215/220/240 or CPE100/CPE115) or a rack-mounted PNC001 module located in the RX3i CPU rack. For rack-mounted PNC001 units, the main RX3i rack can include up to four PNC001 modules, each communicating with its own high-speed network.

IO Devices on the network can consist of the I/O modules installed in a rack, each containing a PROFINET Scanner (PNS) as its head-end, such as the Emerson products listed above. The network may also include a wide range of third-party IO Devices, such as pressure gauges and motor actuators, that are connected directly to the PROFINET network.

1.6.1 Compression

Due to the smaller memory capacities of CPE302, CPE305 and CPE310, these CPUs require "Compression" when attaching RX3i PNS or CEP to their PROFINET configuration.

- CPE302: User **MUST** use Target PLC parameter with **Compression** set to **HIGH**.
- CPE305: User **MUST** use Target PLC parameter with **Compression** set to ***at least* MODERATE**.
- CPE310: User can use Target PLC parameter **Compression** set to **NORMAL**.
- All other CPUs: User can choose to use **Compression** or not.

Note: PME's default compression value for new projects is HIGH. Users are encouraged to use high compression when able.

1.6.2 Basic System: One RX3i CPU and One PROFINET Controller using a single port

Figure 7 shows a basic system with one PACSystems RX3i CPU node having one PROFINET Controller, and one PROFINET network with three VersaMax Scanners and one third-party IO-Device. Up to 128 IO-Devices can be installed on an RX3i PROFINET network. The VersaMax PNS and many types of third-party IO-Devices interface multiple devices such as I/O modules to the PROFINET network.

Figure 7: RX3i System with one PROFINET Controller and one PROFINET LAN

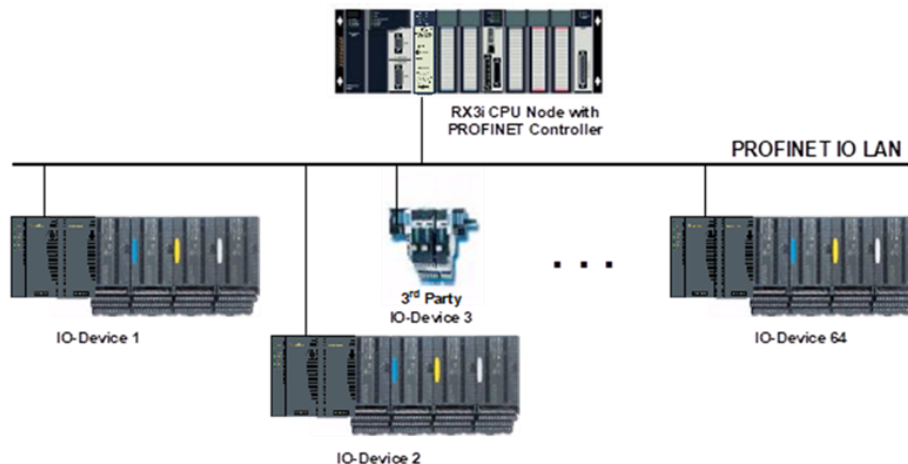

1.6.3 Basic System: One RX3i CPU and One PROFINET Controller using multiple ports

The illustration below shows a basic system with one PACSystems RX3i CPU node that has one RX3i PROFINET Controller module controlling one PROFINET network. The network can connect to 128 compatible IO-Devices, including any combination of Emerson PROFINET Scanners and third-party IO Devices.

Figure 8 shows one RX3i PROFINET Controller that is directly connected to four separate IO Devices in a Star topology. Although each IO Device is connected to a separate Ethernet port on the PNC001, they are all on the same network segment (IO LAN1). The IO-Devices in this example

are all VersaMax PROFINET Scanners, but RX3i PROFINET Scanners (PNS001, PNS101) and third-party IO-Devices may also be used.

Figure 8: RX3i System with one PROFINET Controller and multiple PROFINET LANs

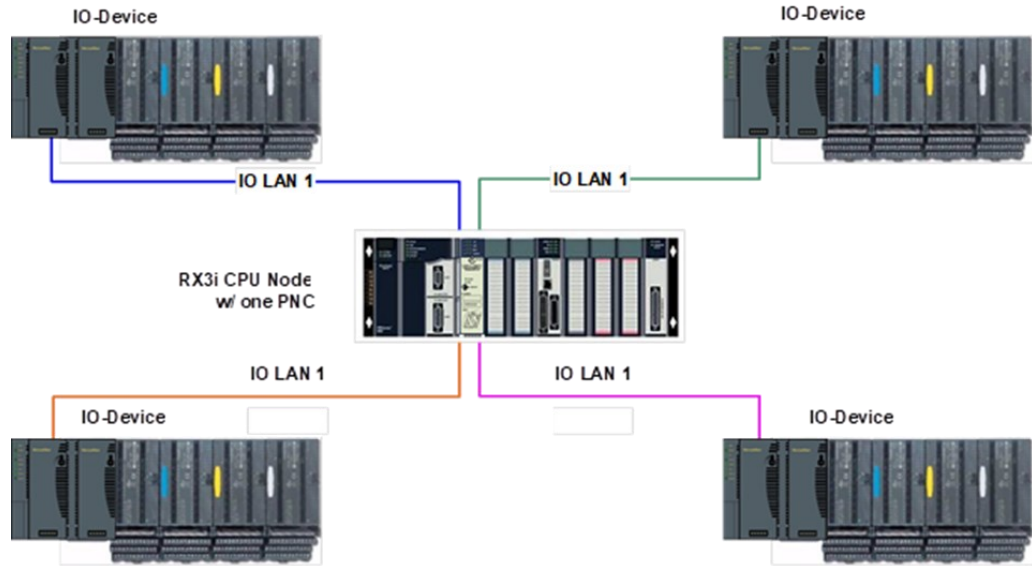

1.6.4 Basic System: Third-Party Devices and PAC Machine Edition Programmer

Third-party IO Devices can be used with the RX3i PROFINET Controller if their manufacturer provides a GSDML file that can be imported into PAC Machine Edition. The GSDML file defines the characteristics of the IO-Device and its I/O modules. Importing a third-party IO Device GSDML file and configuring third-party IO-Devices are described in Section 3, and in the PAC Machine Edition online help.

After receiving a third-party device's configuration, the RX3i PROFINET Controller connects to the third-party IO-Device if the device is available, transfers the configuration to the device, and starts exchanging I/O and alarm data with the device.

Figure 9 shows a programmer connection (for configuration, user logic programming, and monitoring), the concept of GSDML import, an optional external Ethernet switch, and the ability to connect field buses to a PROFINET IO-Device. Third-party IO-Devices that have only one Ethernet port may require the use of an external switch.

Figure 9: RX3i System interfacing with Third-Party Devices and with PAC Machine Edition Programmer

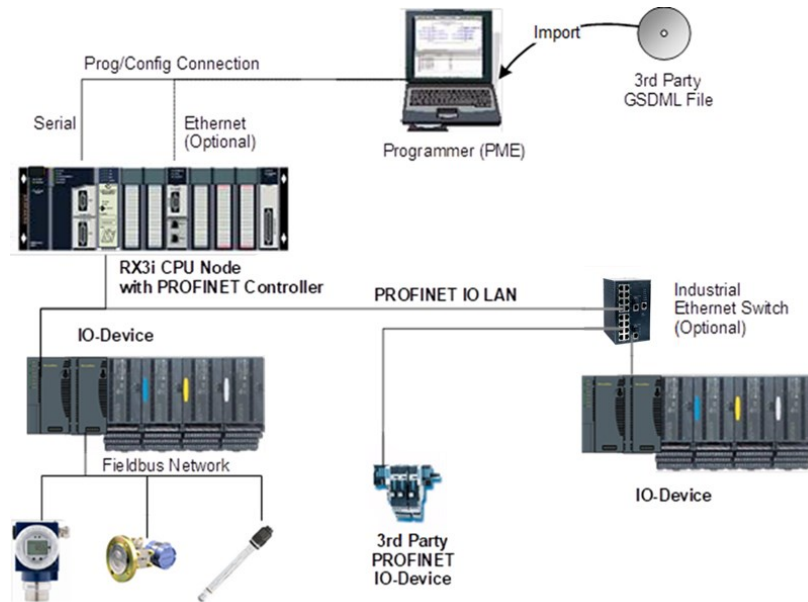

1.6.5 Systems with One RX3i CPU and Two PROFINET Controllers

Both examples in this section show systems with one RX3i CPU that has two PROFINET Controller modules. The PROFINET network can serve up to 63 IO-Devices (ring topology) or 128 IO Devices (in star topology).

Note that multiple PNC001 modules in the same rack are not synchronized; that is, no two PNC001 modules are guaranteed to power up at the same time. PNC001 configuration differences (SFPs, etc.) can also cause variations in PNC001 power-up times.

If two (or more) PNC001 modules are in a main rack and devices owned by one PNC001 are routed through the switch on a different PNC001 in the same rack, devices may show a Loss of Device fault followed by an Addition of Device fault during RX3i power-up because the first PNC001 can power up before the second PNC001 has enabled its Ethernet switch, causing the Loss of Device. Then when the second PNC001 powers up, the device will show an Addition of Device fault, which is to be expected under these circumstances. Devices will function normally once added.

As shown in Figure 10, both PROFINET Controllers are connected to the same network.

Figure 10: RX3i System with two PNC001 Modules and one Daisy-Chain PROFINET LAN

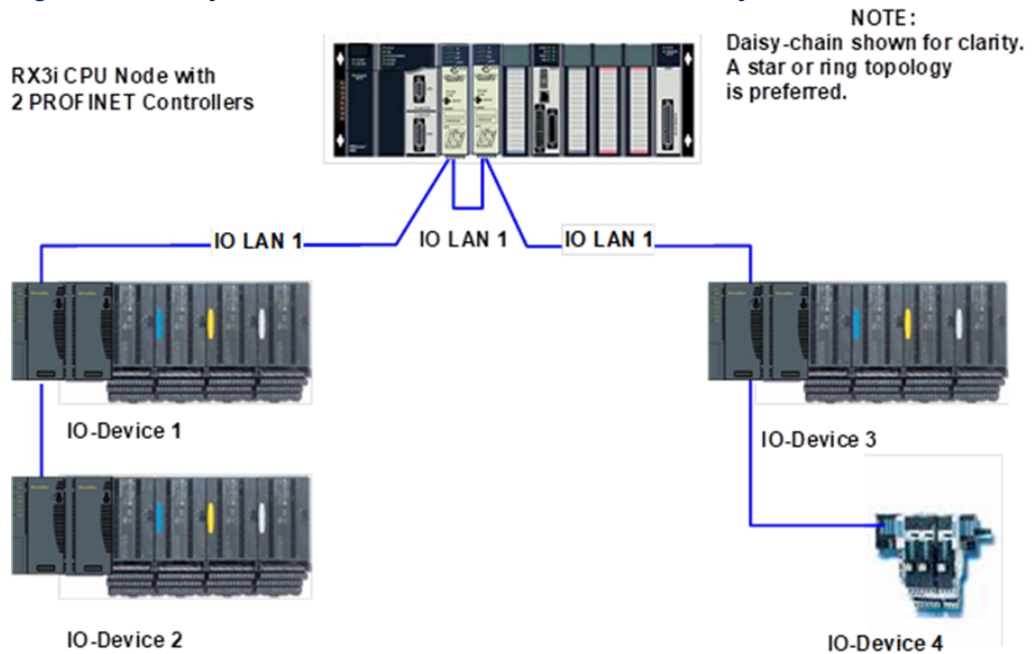

In Figure 11, the two PROFINET Controllers are connected to separate networks. The maximum number of IO-Devices with multiple PROFINET Controllers in the same RX3i controller is 255.

Figure 11: RX3i System with two PNC001 modules and two Daisy-Chain PROFINET LANs

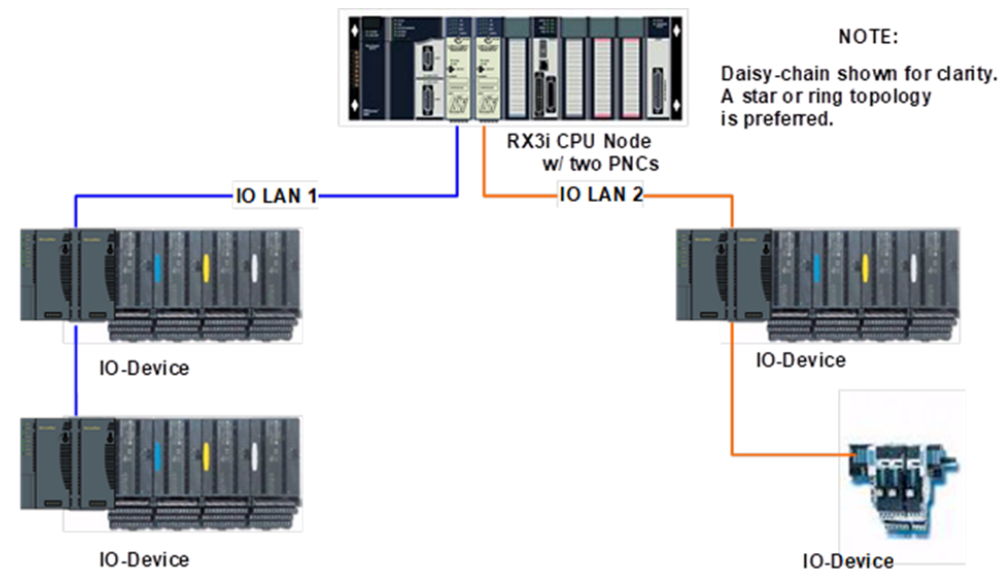

1.6.6 One RX3i CPU with Four Controllers on Separate Networks

Figure 12 shows a system with one RX3i CPU node containing the maximum of four RX3i PROFINET Controllers, with each PROFINET Controller connected to a different network. In this architecture, up to 255 IO-Devices are allowed, spread across the four networks. Up to 128 IO Devices can be controlled by any given PROFINET Controller.

Note that multiple PNC001 modules in the same rack are not synchronized; that is, no two PNC001 modules are guaranteed to power up at the same time. PNC001 configuration differences (SFPs, etc.) can also cause variations in PNC001 power-up times.

If two (or more) PNC001 modules are in a main rack and devices owned by one PNC001 are routed through the switch on a different PNC001 in the same rack, devices may show a Loss of Device fault followed by an Addition of Device fault during RX3i power-up because the first PNC001 can power up before the second PNC001 has enabled its Ethernet switch, causing the Loss of Device. Then when the second PNC001 powers up, the device will show an Addition of Device fault, which is to be expected under these circumstances. Devices will function normally once added.

Figure 12: RX3i System with four PNC001 modules and four Daisy-Chain PROFINET LANs

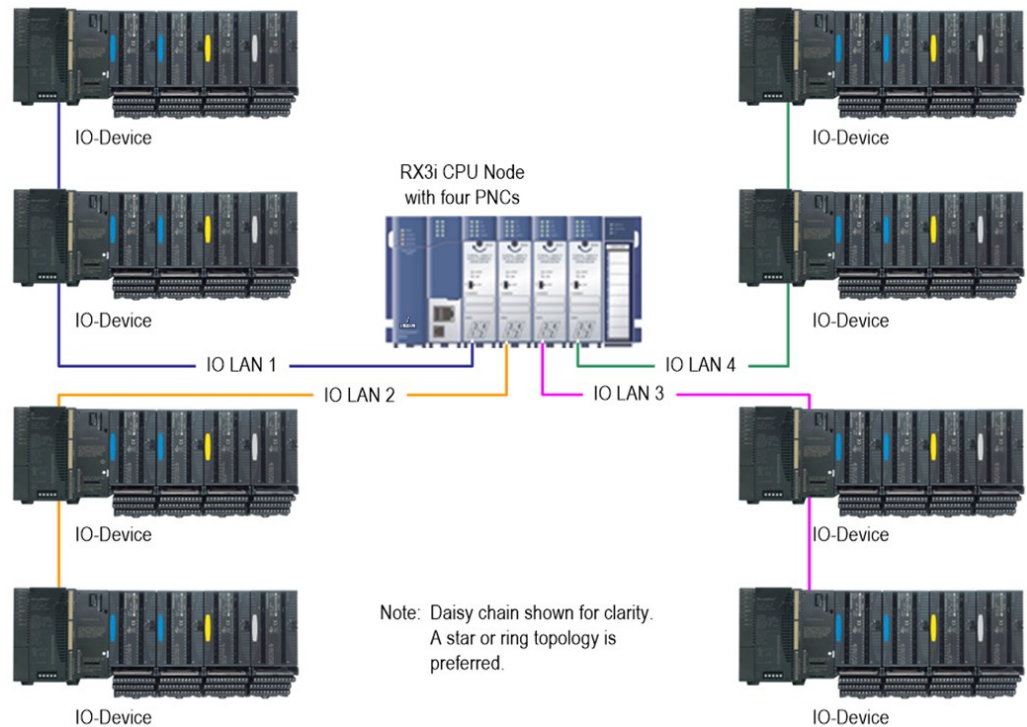

As in the other examples, other Emerson IO-Devices can be substituted for the VersaMax PROFINET Scanners.

1.6.7 Two RX3i CPUs with Two PROFINET Networks and One Ethernet Network

Figure 13 shows two RX3i CPU nodes, each with one RX3i PROFINET Controller module and one RX3i Ethernet Transmitter Module (ETM). The PROFINET Controller modules are connected to separate networks (IO LAN1 and IO LAN2 in the illustration). IO LAN1 and IO LAN2 are used for PROFINET IO traffic.

The RX3i Ethernet Transmitter Modules are connected to the same Ethernet LAN (LAN3 in the illustration). PAC Machine Edition, HMI, and Historian use LAN3 to configure and monitor the application. LAN3 is also used for inter-node communication such as EGD, SRTP, and Modbus/TCP. The three separate networks do not compete for network bandwidth or interfere with one another.

Figure 13: RX3i System with two PROFINET LANs & one Ethernet LAN

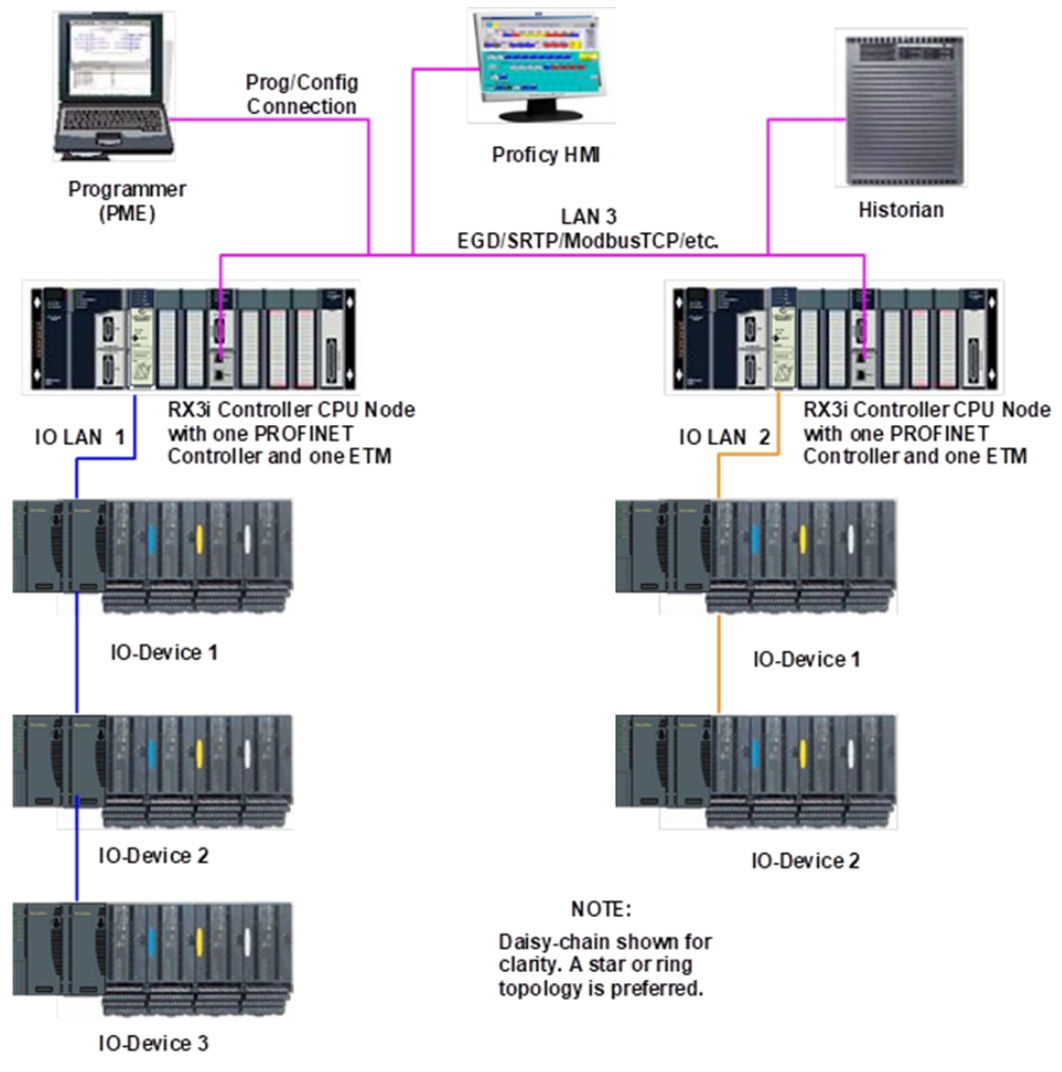

1.6.8 Systems that use PROFINET System Redundancy (PNSR)

PACSystems support S2 type PNSR, as diagrammed in Figure 14. The 'S' denotes that the IO Device has single network support. PROFINET defines an 'R' option in which the IO Device may have redundant network interfaces which could be on different networks. The '2' denotes that the network supports two connections as a set.

Note that in each case the firmware installed in the PROFINET Controller and in the PROFINET Device must themselves support PNSR. PNSR allows a set of Hot standby CPU controllers to have an active and hot backup connection to an IO device, so that if something fails in one CPU controller, the other CPU controller can continue IO operations without disruption.

PNSR relies entirely on PROFINET features to support this configuration. PACSystems only supports PNSR in Dual HWC Hot Standby systems. Within a PNSR system, simplex IO devices may be controlled by one CPU Controller in addition to redundant IO devices which are controlled by the Active CPU of the Hot Standby system. When the CPU controller which is controlling a simplex IO Device is stopped, that IO Device is lost.

The PROFINET PNSR Network may be either Ring or Star formation. Using a Ring formation with the Media Redundancy Protocol (refer to Section 6), is often useful with PNSR systems since a single cable failure is handled by MRP allowing both IO Controllers to maintain connection with the IO devices.

Figure 14: PROFINET System Redundancy S2

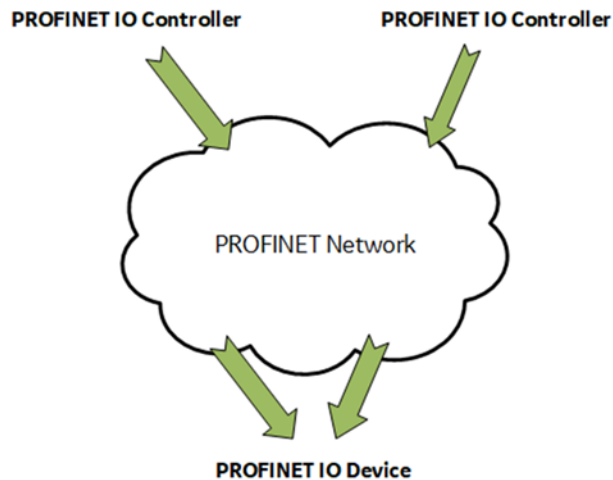

1.6.9 Systems that use Hot Standby CPU Redundancy

Figure 15 shows a Hot Standby CPU Redundancy system that uses a PROFINET I/O network with MRP ring topology. Use of MRP ring topology is recommended because it eliminates the I/O network as a single point of failure. If elimination of a single point of failure is not required, a star topology can be used.

These systems are described in the *PACSystems Hot Standby CPU Redundancy User's Manual*, GFK 2308F or later.

Hot Standby CPU Redundancy Network with MRP Ring Topology

Figure 15: RX3i Hot Standby CPU Redundancy Network with MRP Ring Topology

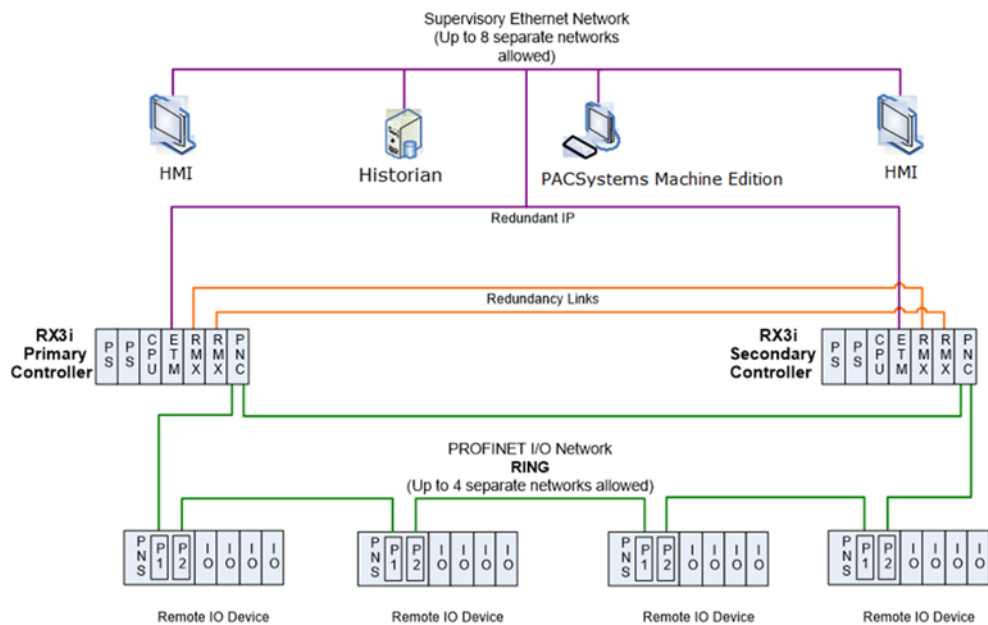

1.6.10 RSTi-EP Standalone CPU with embedded PROFINET Controller using a single port⁴

Figure 16 shows a basic system with one PACSystems RSTi-EP CPU node with embedded PROFINET Controller, and one PROFINET network with two VersaMax, one RSTi-EP Scanners and one third-party IO Device. Up to 8 IO Devices can be installed on an RSTi-EP PROFINET network.

⁴ An RSTi-EP Backplane CPU with embedded PROFINET controller using a single port will use the same topology and configuration.

Figure 16: RSTi-EP System with embedded PROFINET Controller and one PROFINET LAN

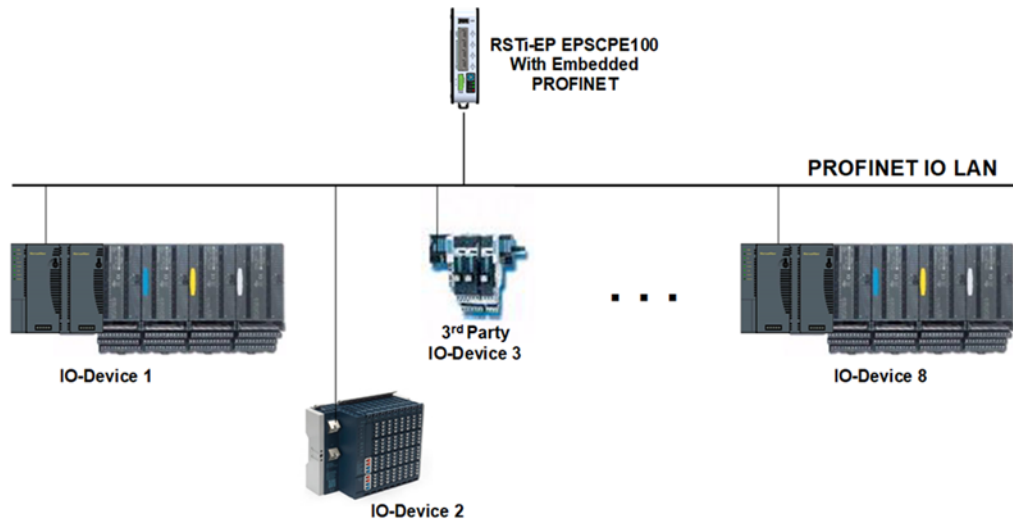

1.6.11 RSTi-EP Standalone CPU with embedded PROFINET Controller using multiple ports⁵

The illustration above shows a basic system with one PACSystems RSTi-EP CPU node with embedded PROFINET Controller controlling one PROFINET network. The network can connect to 8 compatible IO-Devices, including any combination of Emerson PROFINET Scanners and third-party IO Devices.

Figure 17 shows one RSTi-EP CPE100/CPE115 embedded PROFINET Controller that is directly connected to three separate IO Devices in a Star topology. Although each IO Device is connected to a separate Ethernet port, they are all on the same network segment (IO LAN1). The IO-Devices in this example are one VersaMax and two RSTi-EP PROFINET Scanners, but RX3i PROFINET Scanners (PNS001, PNS101) and third-party IO-Devices may also be used.

⁵ An RSTi-EP Backplane CPU with embedded PROFINET controller using multiple ports will use the same topology and configuration.

Figure 17: RX3i System with one PROFINET Controller and multiple PROFINET LANs

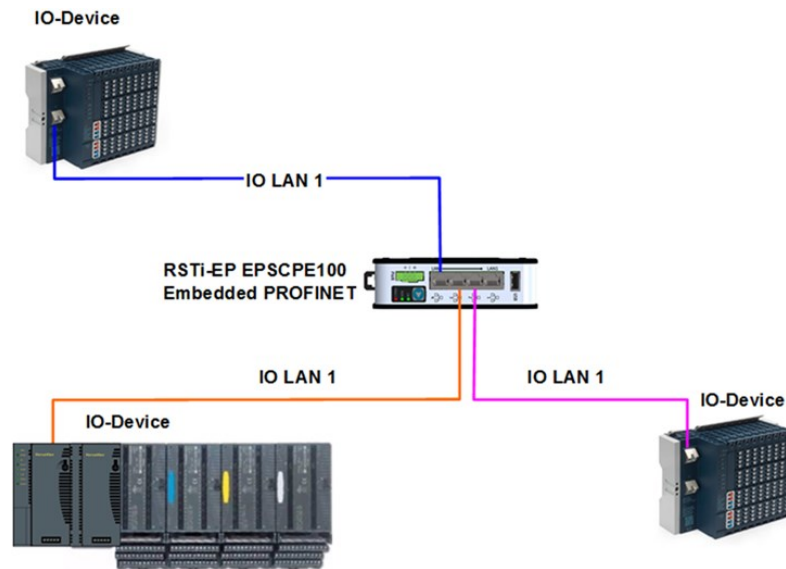

RSTi-EP Standalone CPU with embedded PROFINET Controller using MRP⁶

Figure 18 shows one RSTi-EP CPE100/CPE115 embedded PROFINET Controller that uses a PROFINET I/O network with MRP ring topology. CPE100/CPE115 LAN2 Port 2 & Port 3 support Media Redundancy and on configuring MRP as Manager / Client LAN2 Port 4 can be used for connecting Simplex PROFINET devices or any other Ethernet Protocols such as Modbus, SRTP, and EGD. Use of MRP ring topology is recommended because it eliminates the I/O network as a single point of failure. If elimination of a single point of failure is not required, a star topology can be used.

Figure 18: RX3i System with one PROFINET Controller and PROFINET IO Network MRP

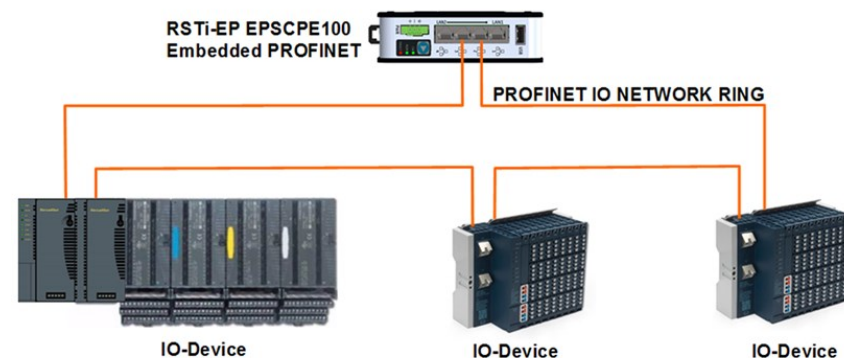

⁶ An RSTi-EP Backplane CPU with embedded PROFINET controller using MRP will use the same topology and configuration.

1.7 Glossary

Term	Definition
AR	Application Relationship. PROFINET term for a relationship that is established between an IO-Controller/Supervisor and IO-Device. For any data to be exchanged between an IO-Controller/Supervisor and a given IO-Device, an Application Relationship must be established. Within the Application Relationship, various Communication Relationships (CRs) are then established for the different types of data to be exchanged.
Broadcast	In Ethernet, the transmission of a network message to all hosts on the network.
CLI	Command Line Interface
CPU Node	In a PACSystems RX3i PROFINET network, a CPU Node is a node in which a PACSystems RX3i CPU is connected to the PROFINET network.
CR	Communication Relationship. PROFINET term for a channel that is established within an Application Relationship (AR) to transfer specific data between an IO-Controller/Supervisor and a given IO-Device. Multiple CRs are established within an AR to transfer data.
Critical Network Port	An Ethernet port connection on the PROFINET I/O Controller that is configured as a critical port. When the last Critical Network Port is disconnected from its network, a diagnostic fault is logged. In a redundancy system where the PROFINET I/O Controller is controlling redundant devices, this results in a CPU redundancy role-switch with the CPU placed into Stop/Fault mode.
DAP	Device Access Point. This access point is used to address an IO-Device as an entity.
Gratuitous ARPs	An Address Resolution Protocol (ARP) request sent by the host to resolve its own IP Address.
GSDML	General Station Description Markup Language - definition of PROFINET Device Characteristics.
IOC	PROFINET IO-Controller
IOD	PROFINET IO-Device
IOCR	Input Output Communication Relationship – describes the type (input/output) and amount of I/O data to be transferred, the sequence of the transfers and the transfer cycle between a PROFINET IO-Controller (or IO-Supervisor) and a PROFINET IO-Device.
IOCS	PROFINET Input/output Consumer Status is transmitted on the PROFINET network to provide feedback on Input Data for an IO controller and Output Data for an IO device.
IOPS	PROFINET Input/output Provider Status is transmitted on the PROFINET network to provide feedback on Output Data for an IO controller and the Input Data for an IO device.
IOxS	PROFINET abbreviation for the IOCS and/or IOPS (see above).
LLDP	Link Layer Discovery Protocol. IEEE standardized protocol used by network devices to advertise their identity and capabilities.
LLDPDU	Link Layer Discovery Protocol Data Unit.
MAC	Media Access Control address (MAC address)
MAU	Medium Attachment Unit

Term	Definition
MIB	Management Information Basis
MRC	Media Redundancy Client. Within Media Redundancy Protocol, an MRC is responsible for helping the MRM detect breaks/no breaks in the ring.
MRM	Media Redundancy Manager. Within Media Redundancy Protocol, an MRM is responsible for ensuring that the ring does not have a closed loop, while simultaneously ensuring maximal connectivity between nodes on the ring.
MRP	Media Redundancy Protocol. An Ethernet protocol that provides redundant paths for PROFINET-IO cyclic traffic by supporting a ring topology.
Multicast	In Ethernet, the transmission of a network message to all hosts within a host group.
NOS	Name of Station
OID	Object Identifier
Phase	If the IOCR Update Period is greater than the Send Clock time, the Update Period is divided into multiple phases where each phase is equal to one Send Clock.
PNC	PROFINET Controller: Typically, the generic PROFINET Controller function. PNC001 represents a slot-mounted product (IC695PNC001). Embedded PROFINET Controllers may be configured on LAN2 for CPL410, CPE400, CPE330, EPXCPE205/210/215/220/240 and CPE100/CPE115. Both embedded and slot-mounted perform the same functions on the PROFINET network, but there are differences to be noted in installation, configuration, operation, and performance.
PNS	PROFINET Scanner. Head-end module that controls I/O in rack and communicates with PROFINET network. Both RX3i (IC695PNS001) and VersaMax (IC200PNS001, IC200PNS002) modules are discussed in this manual.
PNSR	PROFINET System Redundancy: the PROFINET processes and mechanisms by which an IO-Device is controlled by multiple IOCs in redundant PLCs.
RDO	Record Data Object. Services used to read and write structured data stored in a PROFINET IO-Device.
Reduction Ratio	Along with Send Clock determines the Update Period for a PROFINET cyclic data transfer between two devices (see IOCR). The Update Period equals the Reduction Ratio multiplied by the Send Clock time. For example, if the Reduction Ratio is 4 and the Send Clock is 1ms, the Update Period is 4ms.
Remote Node	For an RX3i PROFINET network, a Remote Node is any PROFINET IO-Device, such as a rack of I/O modules with a Remote Scanner or a third party PROFINET IO-Device.
RIV	Reference ID Variables
RTA	Real-Time Acyclic. A PROFINET-IO Mechanism used to exchange non-periodic data such as alarms.
RTC	Real-Time Cyclic. A PROFINET-IO Mechanism used to exchange input and output data.
Send Clock	Value between 1 and 128 inclusive in units of 31.25 μ s (equivalent to a range of 31.25 μ s to 4 ms) used to calculate the Update Period for a PROFINET cyclic data transfer between two devices (see IOCR). The Send Clock is the basis for all other scheduling parameters.

Term	Definition
Send Offset	The time to delay a scheduled PROFINET cyclic data transfer frame. Measured in nanoseconds from 0 to 3,999,999. Must be less than the Send Clock time.
SFP	Small Form-factor Pluggable. Pluggable, hot-swappable transceivers.
SNMP	Simple Network Management Protocol. UDP-based network protocol that facilitates the exchange of management information between network devices.
Status Bits	Module status data in RX3i CPU reference memory.
Submodule	PROFINET-IO representation of the smallest configurable entity of a PROFINET Module.
SVC_REQ	Service Request Function Block. A control system service initiated by the RX3i CPU.
TLV	Type-Length-Value
Unicast	In Ethernet, the transmission of a network message to an individual host.
Update Period	The time between PROFINET cyclic data transfers between an IO-Controller and an IO-Device.
USB	Universal Serial Bus
WinLoader	A software utility used to download and install firmware upgrades via a serial port.

1.8 Documentation

PACSystems Manuals

PACSystems RX7i, RX3i and RSTi-EP CPU Reference Manual	GFK-2222
PACSystems RX7i, RX3i and RSTi-EP CPU Programmer's Reference Manual	GFK-2950
PACSystems Hot Standby CPU Redundancy User Manual	GFK-2308
PACSystems Battery and Energy Pack Manual	GFK-2741
PAC Machine Edition Logic Developer Getting Started	GFK-1918
PACSystems Process Systems Getting Started Guide	GFK-2487
PACSystems RXi, RX3i, RX7i and RSTi-EP Controller Secure Deployment Guide	GFK-2830

RX3i Manuals

PACSystems RX3i System Manual	GFK-2314
PACSystems RX3i PROFINET Controller Command Line Interface Manual	GFK-2572
PACSystems RX3i Max-On Hot Standby Redundancy User's Manual	GFK-2409
PACSystems RX3i PROFINET Scanner Manual	GFK-2737
PACSystems RX3i CEP PROFINET Scanner User Manual	GFK-2883
PACSystems HART Pass Through User Manual	GFK-2929
PACSystems RX3i PROFINET Scanner Important Product Information	GFK-2573

VersaMax Manuals

VersaMax PROFINET Scanner Manual

GFK-2721

In addition to these manuals, datasheets and product update documents describe individual modules and product revisions. The most recent PACSystems documentation is available on the support website <https://www.emerson.com/Industrial-Automation-Controls/support>.

Section 2 Installation

This Section provides instructions for installing PACSystems RX3i PROFINET Controller modules.

- Pre-Installation check
- Removing the backplane knockout
- Module installation and removal
- Hot insertion and removal
- Port connections
- Installing SFP devices
- LED indications
- Installing the USB Port Driver
- Firmware updates
- Time synchronization with RX3i CPU

For additional information about system installation, also refer to the PACSystems RX3i Systems Manual, GFK-2314.

2.1 Pre-Installation Check

Upon receiving your RX3i equipment, carefully inspect all shipping containers for damage. If any part of the system is damaged, notify the carrier immediately. The damaged shipping container should be saved as evidence for inspection by the carrier.

As the consignee, it is your responsibility to register a claim with the carrier for damage incurred during shipment. However, Emerson will fully cooperate with you, should such action be necessary.

After unpacking the RX3i equipment, record all serial numbers. Serial numbers are required if you should need to contact Customer Care during the warranty period. All shipping containers and all packing material should be saved should it be necessary to transport or ship any part of the system.

Verify that all components of the system have been received and that they agree with your order. If the system received does not agree with your order, contact Customer Care.

If you need technical help, contact Technical Support. For phone numbers and email addresses, see the Contact Information page in the front of this manual.

2.2 Installation in Hazardous Areas

EQUIPMENT LABELED WITH REFERENCE TO CLASS I, GROUPS A, B, C & D, DIV. 2 HAZARDOUS LOCATIONS IS SUITABLE FOR USE IN CLASS I, DIVISION 2, GROUPS A, B, C, D OR NON-HAZARDOUS LOCATIONS ONLY.

⚠ WARNING

- EXPLOSION HAZARD - SUBSTITUTION OF COMPONENTS MAY IMPAIR SUITABILITY FOR CLASS I, DIVISION 2.
- EXPLOSION HAZARD - WHEN IN HAZARDOUS LOCATIONS, TURN OFF POWER BEFORE REPLACING OR WIRING MODULES.
- EXPLOSION HAZARD - DO NOT CONNECT OR DISCONNECT EQUIPMENT UNLESS POWER HAS BEEN SWITCHED OFF OR THE AREA IS KNOWN TO BE NON-HAZARDOUS.
- EXPLOSION HAZARD - USB PORT IS ONLY FOR USE IN NON-HAZARDOUS LOCATIONS, DO NOT USE UNLESS AREA IS KNOWN TO BE NON-HAZARDOUS.

2.2.1 ATEX Marking

Ex II 3 G Ex nA IIC T5 X Ta: 0 - 60C

2.3 Removing the Backplane Knockout

The IC695PNC001 must be installed in the main (CPU) rack of the RX3i system, using a Universal Backplane such as IC695CHS007, CHS012 or CHS016. For details, refer to the PACSystems RX3i System Manual, GFK 2314.

The rear of the PNC001-Ax module has an exposed heat sink and backplane connector. Before inserting the module into the backplane, remove the plastic knockout in the slot into which the module will be placed. The installation slot must match the slot selected for the module in the PAC Machine Edition hardware configuration. This action is not required for PNC001-Bxxx. However, if the knockout has been previously removed, the PNC001-Bxxx can still be inserted into that slot location.

Figure 19: RX3i Backplane showing Removable Plastic Knockout

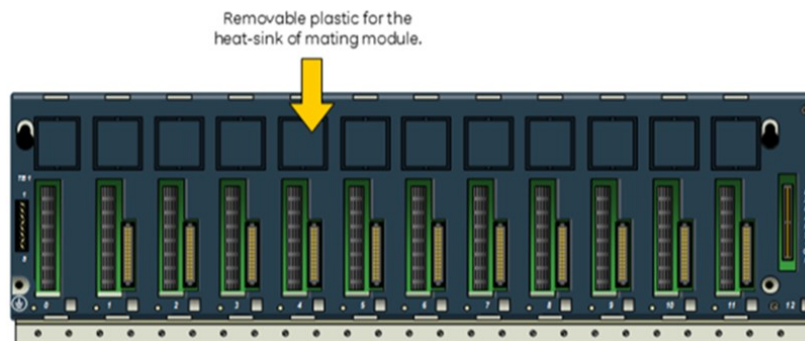

2.4 Module Installation

- RX3i rack power may be off or on (see Hot Insertion and Removal for details).
- Holding the module firmly, align the module with the correct slot and connector.

- Engage the module's rear pivot hook in the notch on the top of the backplane (1).
- Swing the module down (2) until the module's connector engages the backplane's backplane connector, and the release lever (PNC001-Ax only) on the bottom of the module snaps into place in the bottom module retainer (3).
- Visually inspect the module to be sure it is properly seated.
- PNC001-Ax: Tighten the heat sink screw on the front of the module in the threaded hole in the back plate to 6 in-lbs (0.68 Nm), using a flat-tip screwdriver.
- PNC001-Bxxx: Secure the bottom of the module to the backplane using the two captive Phillip's head machine screws provided with the module (not shown in diagram).

Figure 20: Install Module into RX3i Backplane

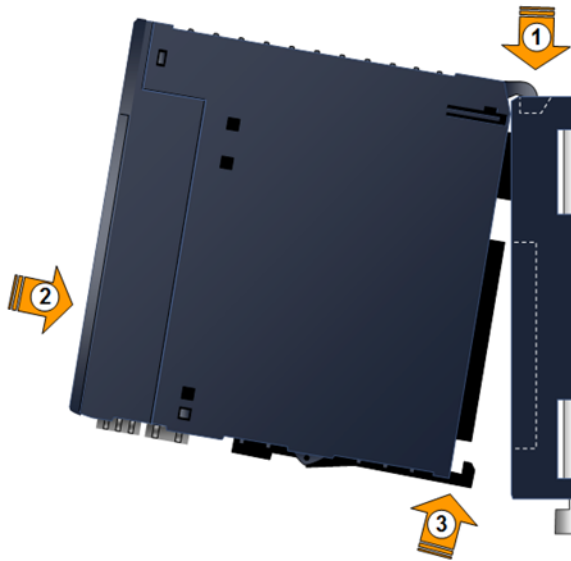

2.5 Module Removal

- RX3i rack power may be off or on (see Hot Insertion and Removal for details).
- PNC001-Ax: Loosen the heat sink screw on the front of the module to release the heat sink from the backplane's aluminum back plate.
- PNC001-Ax: Locate the release lever at the bottom of the module and firmly press upward (1), toward the module.
- PNC001-Bxxx: Loosen the two captive Phillip's head machine screws at the bottom of the module.
- While holding the module firmly and fully depressing the release lever (PNC001-Ax only), pivot the module upward until its connector is out of the backplane (2).
- Lift the module up and away from the backplane to disengage the pivot hook (3).

Figure 21: Remove Module from RX3i Backplane

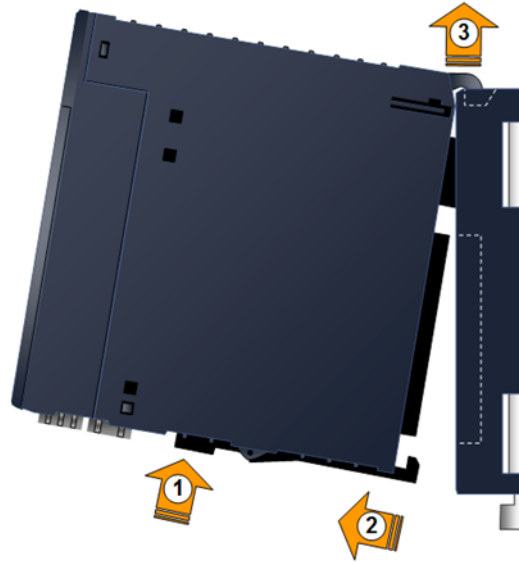

2.6 Hot Insertion and Removal

Modules in a Universal Backplane can be installed or removed while power is applied to the system. This includes backplane power and field power supplied to the module. For a full discussion of this topic, refer to the Hot Insertion and Removal section in the *PACSystems RX3i System Manual*, GFK 2314.

The PNC001 module must be properly seated with the latch engaged (PNC001-Ax only) and all pins connected within two seconds. For removal, the module must be completely disengaged within two seconds. It is important that the module not remain partially inserted during the insertion or removal process. There must be at a minimum of two seconds between the removal and insertion of modules.

⚠ WARNING

- Inserting or removing a module with power applied to the system may cause an electrical arc. This can result in unexpected and potentially dangerous action by field devices. Arcing is an explosion risk in hazardous locations. Be sure that the area is non-hazardous or remove system power appropriately before removing or inserting a module.
- If the surrounding air operating temperature of the PNC001 module is greater than 40°C (104°F), SFP devices could reach operating temperatures over 70°C (158°F). Under these conditions, for your safety, do not use bare hands to remove an SFP device from the SFP cage. Use protective gloves or a tool (needle-nose pliers) to avoid handling the hot SFP device directly when removing the SFP device.

⚠CAUTION

- If an RX3i PROFINET Controller is extracted from a powered RX3i backplane, it loses power immediately, which may result in data loss. Do not remove or insert the device while downloading hardware configuration to the system.
- When the module is plugged back into a powered backplane, the PNC001 module restores data from the internal non-volatile memory. If, however, the RX3i CPU has configuration data for the PROFINET Controller, it re-delivers the data to the PNC001 module, superseding parameters previously stored in non-volatile PNC001 memory.

Fault Notifications

Removing a PROFINET Controller causes a *Loss of IOC* fault in the RX3i CPU's I/O Fault Table and inserting a PROFINET Controller causes an *Addition of IOC* fault in the I/O Fault Table.

2.7

Ethernet Port Connections

Each port on an RX3i PROFINET Controller operates independently. This is true for all ports on the PNC001 module and for ports assigned to embedded PROFINET Controllers. In this way, devices that operate at different speeds and/or duplex modes may be attached to a compatible port. Each port automatically detects the attached cable and functions properly with either straight-through or crossover cables.

Note: *All PROFINET Controller ports operate in auto-negotiate mode only. All PROFINET devices and switches that are connected to the PROFINET Controller should be configured to use auto-negotiation.*

Figure 22: Ethernet Ports on PNC001 Module

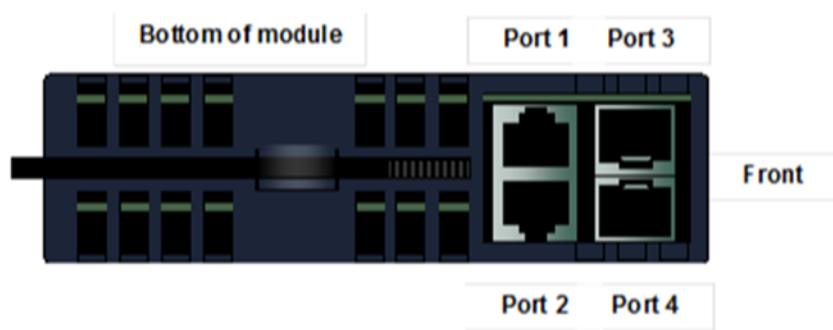

2.7.1

PROFINET Network Connections

Connections to the PROFINET Controller can be made using standard cables. The PROFINET Controller can be connected to only one PROFINET network. However, different devices on the same LAN can be connected via more than one port.

Note: *Shielded cable is required for 1 Gbps operation*

⚠CAUTION

Do not connect two or more ports on the PROFINET Controller to the same device, either directly or indirectly, unless Media Redundancy is enabled in the PROFINET Controller's configuration. If Media Redundancy will be used, do not close the network ring until after a Media Redundancy

configuration that contains one node as a Media Redundancy Manager (MRM) has been downloaded to the PROFINET Controller. If a Media Redundancy Manager is not present, packets can continuously cycle on the network, preventing normal operation. For more information refer to Section 6 Redundant Media.

2.7.2 RJ45 Port Connections

The RJ45 ports on the underside of the PNC001 module can be used for PROFINET network connections or for general Ethernet communications on a 10BaseT, 100BaseTX, or 1000Base-T IEEE 802.3 network. Typical switches, hubs, or repeaters support 6 to 12 nodes connected in a star wiring topology.

For embedded PROFINET Controllers, LAN2, when configured as an Ethernet port, does not permit PROFINET functions. However, once configured as a PROFINET Controller, LAN2 continues to support the Ethernet modality. In other words, it is possible to have Ethernet protocols running on the network while it is configured for PROFINET. This can be tolerated so long as the Ethernet traffic does not impede or degrade PROFINET operations.

10BaseT: uses a twisted pair cable of up to 100 meters in length between a node and another node, switch, hub, or repeater. 10Mbps may be used for the Command Line Interface (CLI) and general Ethernet traffic, but not for PROFINET communications.

100BaseTX: uses a cable of up to 100 meters in length between a node and another node, switch, hub, or repeater. The cable should be data grade Category 5 or better unshielded twisted pair (UTP) or shielded twisted pair (STP).

1000BaseT: uses a cable of up to 100 meters in length between a node and another node, switch, hub, or repeater. The cable should be data grade Category 5 or better shielded cable.

Network Cabling and Connector Types

Copper: up to 100 Meters between Devices

All these products use RJ45 connectors for copper connections. Copper cabling and connections are easily available in the general market and support distances of up to 100m.

Figure 23: Interconnect using Copper Cables / RJ45 Connectors



Multi-Mode Fiber: up to 2 km between Devices

Multi-Mode Fiber supports two types of connectors: LC and SC. The LC connector is used on SFPs on the RX3i PNC001 and on the PNS modules. The SC connector is used on the VersaMax PNS. Cables are available with LC-to-LC connectors and LC-to-SC connectors to match the different connector formats. Multi-Mode fiber can support distances up to 2Km at 100Mbps. When using fiber, pay attention to the cable connector and cable radius clearance requirements in cabinet planning and layout.

Figure 24: Interconnect using Multi-Mode Fiber



Single-Mode Fiber: up to 70 km between Devices

Single-Mode Fiber is supported between SFPs using the LC connector. Single-Mode fiber can support distances up to 70 km. As with the Multi-mode fiber, pay attention to the cable connector, radius, and minimum length requirements in planning the installation.

Figure 25: Interconnect using Single-Mode Fiber



Network Cabling and Connector Examples

Figure 26: CAT5e/CAT6 (shielded or unshielded) with RJ 45 Connector



Figure 27: Multi-Mode Fiber with LC connector



Figure 28: Single-Mode Fiber with LC connector



2.7.3

Installing SFP Devices

SFP (Small Form-Factor Pluggable) devices can be installed in Port 3 and Port 4 of the PROFINET Controller. See SFP Modules for Ethernet Ports for a list of supported SFP devices, media types,

and distances. The specific SFP module installed in each cage must be defined in the PAC Machine Edition configuration of the PNC001.

Keep the protective plug installed in the SFP device. Following the manufacturer's installation instructions, insert the device with its electrical contacts oriented toward the inside of the PNC001 until it clicks into place.

Figure 29: Method for Attaching SFP Device Connector to PNC001 Port

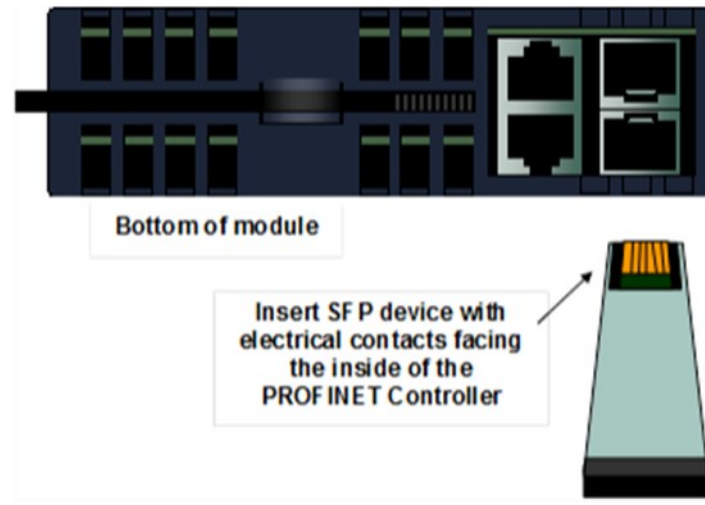

⚠ WARNING

Optical SFPs use an invisible laser to generate a fiber-optic signal. Always keep the port covered if a cable is not installed. Do not peer into the open port if a cable is not installed

Remove the protective plug to install the cable.

When the PNC001 powers up, it automatically detects devices plugged into the SFP cages, their type (fiber, copper, etc.) and their link speed. If an SFP device has been included in the configuration but is not present in the specified cage, the PNC001 logs a Loss of Network Port entry to its Local Log Table. If possible, the PROFINET Controller also logs a fault to the associated RX3i I/O Fault Table. The module continues to operate with a Loss of Network Port fault.

If the installed SFP device is different from what has been configured, the PNC001 logs a mismatch entry to its Local Log table. If possible, it also logs an informational fault to the associated RX3i controller's Fault Table. The module tries to configure and use the SFP if it is compatible (as listed in SFP Modules for Ethernet Ports). If the PROFINET Controller detects an unsupported SFP type on power-up or when the SFP is inserted, the PNC001 adds an entry into its Local Log Table and the RX3i I/O Fault Table (if possible) and turns the associated port LED red.

SFP Modules for Ethernet Ports

Each Small Form-Factor Pluggable (SFP) cage on the bottom of a PROFINET Controller module can accept a:

- 10/100/1000 Mbps copper SFP,
- 100Mbps Single-Mode Fiber SFP,
- 100Mbps Multi-Mode Fiber SFP,
- 1000Mbps Single-Mode Fiber SFP, or

- 1000Mbps Multi-Mode Fiber SFP device.

SFP devices can be removed/replaced during module operation. The RX3i PROFINET Controller supports the SFP devices listed below. An SFP type other than those listed below can be configured as a GENERIC SFP in PAC Machine Edition. The RX3i PROFINET Controller will attempt to operate with a generic SFP that identifies itself as an Ethernet SFP. Since SFP types other than those listed below have not been validated, correct operation cannot be guaranteed.

SFP Type	Wavelength (nm)	Media Type	Core Size (μm)	Modal Bandwidth (MHz – km)	Distance (m)
100BASE-FX	1300	MMF	62.5	500	2 – 2,000 (Full-Duplex)
			50	400	
			50	500	2 – 400 (Half-Duplex)
100BASE-LX10	1300	SMF	9	-	2 – 10,000
1000BASE-SX	850	MMF	62.5	160	2 – 220
				200	2 – 275
			50	400	2 – 500
				500	2 – 550
1000BASE-LX	1300	SMF	9	-	2 – 10,000
1000BASE-ZX	1550	SMF	9	-	2 – 70,000
10/100/1000 BASE-T	-	CAT5/ CAT5e /CAT6	-	-	100 (maximum)

Typical SFP Modules

Below are images of the two types of Ethernet SFPs. The Single- and Multi-Mode Fiber SFPs accept an LC Connector. The Copper SFPs accept an RJ45 connector

Figure 30: Fiber SFP showing LC Connector



Figure 31: Copper SFP showing RJ45 Connector



2.7.4 Removing SFP Devices

⚠ WARNING

If the surrounding air operating temperature of the PNC001 module is greater than 40°C (104°F), SFP devices could reach operating temperatures over 70°C (158°F). Under these conditions, for your safety, do not use bare hands to remove an SFP device from the SFP cage. Use protective gloves or a tool (needle-nose pliers) to avoid handling the hot SFP device directly when removing the SFP device.

Remove the cable from the SFP device. If the device has a latching mechanism such as a bale clasp, open it gently. Do not pull on the latching mechanism. Hold the sides of the SFP device and pull it out of the PROFINET Controller port.

2.9 PNC001 LED Behavior

2.9.1 Power-up LED Patterns

At power-up, the LEDs show the blink patterns described below. The LEDs also blink diagnostic patterns for certain operating errors and for module identification. See Section 5 Diagnostics for a description of those special blink patterns.

Step	LED/Blink pattern	Description
1	All LEDs OFF	Normal operation
1.1	ACTIVE LED solid green (PNC001-Bxxx only)	Normal operation
1.2	CONFIG LED solid green (PNC001-Bxxx only)	Normal operation
2	STATUS LED solid green	Normal operation
	OK LED blinks Amber with special blink code	Fatal Initialization or Diagnostics Failure, Hardware Module Identity Information not available
	OK, LAN, and STATUS LEDs blink green in unison (1 Hz)	Invalid firmware detected. Module is waiting for firmware update. Blink pattern continues during firmware update.
3	LAN and STATUS LED solid green (PNC001-Ax only)	Normal operation
4	LAN LED solid green	Normal operation
	LAN and STATUS LED blink green (1 Hz)	Update of module firmware. After the automatic update completes, the LEDs blink Amber and the module resets, which restarts the power-up process.
5	OK LED solid green	Normal operation. Power up completed and backplane communications established.
	OK LED blinks green (1 Hz)	Module power-up completed, but communication not yet established over the RX3i backplane.

Figure 32: PNC001-Bxxx Front View showing LEDs

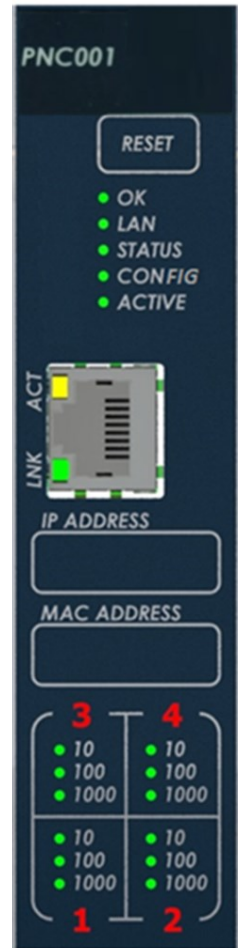





Note: Under certain ambient operating temperatures, the PROFINET Controller may momentarily display the overtemperature pattern during power up, while it is calibrating its thermal protection functions. This indication may be ignored, and no overtemperature entry is added to the Local Log table, the Controller Fault Table, or I/O Fault Table.

For details, see *Special LED Pattern - Module Identification* in Section 5, Diagnostics.

2.9.3 Detailed LED Descriptions



OK LED

The OK LED indicates whether the module can perform normal operation.

	Green, ON	OK
	Green, blink pattern	Fatal error. Flashes once between error codes blinked on the OK LED
	Amber, blink pattern	Fatal error
	OFF	Not OK

LAN LED





The LAN LED indicates access to and activity on the Ethernet network. The LAN LED indicates network packets are being processed by the network interface (not just passing through the embedded switch).

	Blinking ON	The module's network interface is active
	Blink pattern	Fatal error. Flashes once between error codes blinked on the OK LED
	OFF	No activity

STATUS LED



The STATUS LED indicates the condition of the PROFINET Controller during normal operation. It indicates whether an entry other than the startup event is present in the module's Local Log. STATUS can also indicate whether any of the MAC addresses are invalid.

The STATUS LED state is reset when the Local Log is cleared. For more information see the Command Line Interface clear log command.

	Green, ON	No new Local Log table entries
	OFF	New Local Log table entry
	Green, blink pattern	Fatal error. Flashes once between error codes blinked on the OK LED. Section 5 Diagnostics provides more detailed information about this LED's additional behavior during fatal error conditions.
	Red, blinking	Invalid MAC address (all MAC addresses are validated; error indicates if any address is bad).



CONFIG LED

The CONFIG LED indicates whether the module has received its configuration from the RX3i CPU.

	Green, ON	Configured
	OFF	Not configured
	Green, blink pattern	Fatal error. Flashes once between error codes blinked on the OK LED





USB LED

The USB LED (PNC001-Ax only) indicates activity on the USB port.

	Green, Blinking	USB port activity
	Green, blink pattern	Fatal error. Flashes once between error codes blinked on the OK LED
	OFF	No USB port activity

ACTIVE LED

The ACTIVE LED indicates the overall status of PROFINET connections.



	Green, ON	All configured PROFINET devices have established PROFINET connections
	Green, blink pattern	Fatal error. Flashes once between error codes blinked on the OK LED
	Amber, ON	At least one configured PROFINET device has established a PROFINET connection, but other configured PROFINET devices are not connected
	OFF	No configured PROFINET Devices have established PROFINET connections to the PROFINET Controller, or hardware configuration is cleared.

Port LEDs



The PNC001 has LEDs that indicate link speed, link connection and link activity corresponding to the four possible external switched Ethernet ports. The layout and behavior of these LEDs is different depending on the revision of the PNC as shown below.

Revision -Bxxx:



Port Number LED (Note: here the digit representing the port number is backlit by the corresponding LED).

	Red, ON	Port 3 and 4 only: Error such as incompatible SFP.
	OFF	No Port errors.



1000 Speed LED (individual LED for each port)

	Green, ON	Link connected, 1000 Mbps
	Green blinking	Port active, 1000 Mbps
	OFF	The associated Ethernet port is not connected to an active link at 1000Mbps

100 Speed LED (individual LED for each port)









	Green, ON	Link connected, 100 Mbps.
	Green, blinking	Port active, 100 Mbps
	OFF	The associated Ethernet port is not connected to an active link at 100Mbps

10 Speed LED (individual LED for each port)

	Green, ON	Link connected, 10 Mbps.
	Green, blinking	Port active, 10 Mbps
	OFF	The associated Ethernet port is not connected to an active link at 10Mbps

Revision -Ax:

LEDs marked 1,2,3,4 behave as follows:

	Blue, ON	Link connected, 1000 Mbps
	Blue, blinking	Port active, 1000 Mbps
	Green, ON	Link connected, 100 Mbps
	Green, blinking	Port active, 100 Mbps
	Purple, ON	Link connected, 10 Mbps
	Purple, blinking	Port active, 10 Mbps
	Green, blink pattern	Fatal error. Flashes once between error codes blinked on the OK LED
	OFF	The associated Ethernet port is not connected to an active link
	Red, ON	Port 3 and port 4 only. Incompatible SFP plugged into port.

2.10 Installing the USB Port Driver

The USB Ports on CPUs which support the embedded PROFINET function operate independently of the PROFINET Controller function itself. Refer to the documentation for the related CPU.

For the slot-mounted PNC001 (-Ax module only), set up use of the module's USB port in either of these ways:

1. Run the provided driver-install application before connecting the computer's USB port to the USB port on the PNC001 module for the first time.
2. With the provided installation files accessible on either a local or network drive, attach the PC USB port to the Rx3i IO LAN USB port.
 - a) Windows opens a New Hardware Found Wizard dialog. Within the wizard application, enter the location of the provided installation files.
 - b) Windows then installs the USB driver compatible with the USB port.

The computer automatically assigns a serial port name for the USB port on the PNC001 module. A unique serial port number will be used for each PNC001 module. The serial port name is COM followed by the next available number from 1 to 256. After the computer assigns the module's USB port a COM port name, it uses the same name each time it connects to the module (except for a special case described below).

If the computer has already assigned all its available port names (COM1 through COM256), the next device to attach is assigned a previously-used COM Port name:

1. If the last assigned COM port name was COM256, the next COM port name assigned is the first unconnected COM port after the physical serial communications ports.
2. If the last assigned COM port name was not COM256, the next COM port name assigned is the first unconnected COM port in sequence.

After the initial installation process, the same computer can be attached to other RX3i PNC001 modules without additional installation steps. The virtual serial port name is automatically assigned when the device is attached to the computer.

Serial port settings must be 115200 baud, 8-None-1, with no flow control.

2.11 Firmware Updates

2.11.1 PNC001 Firmware Updates

Firmware for PNC001-Ax is only compatible with PNC001-Ax hardware. Firmware for PNC001-Bxxx is only compatible with PNC001-Bxxx hardware. They are not interchangeable.

The RX3i PROFINET Controller firmware is updated via the CPU in the rack in which the PNC001 module is located. If the CPU is equipped with a serial port, use the WinLoader utility. If the CPU is not equipped with a serial port, use the http/web-based firmware update method. For detailed instructions, see the firmware upgrade instructions included in the ZIP file, along with the firmware image file.

The current firmware version of the RX3i PROFINET Controller may be obtained using either the PAC Machine Edition programmer (Online Commands->Show Status->Details), or (for PNC001-Ax only) the Command Line Interface *node* command.

2.11.2 Firmware Updates for Embedded PROFINET

For firmware updates to those CPUs that support embedded PROFINET, refer to the documentation for the related CPU. Updating the CPU firmware automatically updates the embedded PROFINET component. PNC001 Time Synchronization with the Host RX3i CPU

The internal clock value of a PNC001 module may be displayed in Command Line Interface (CLI) commands, and it is used to timestamp entries in the PROFINET Controller Local Fault Log as they occur.

The internal clock of the PNC001 module is synchronized with the RX3i CPU clock whenever the PNC001 module is:

- Powered up, or
- Hot-inserted, or
- Reset via the Reset pushbutton, or on command from the Command Line Interface.

Storing hardware configuration to the PNC001 module does not cause clock synchronization.

If the host CPU's time is changed after the PNC001 module synchronizes its own internal clock, the PROFINET Controller's internal clock is not automatically synchronized until the PNC001 module is again powered up, hot-inserted, or reset.

The internal clock of the PNC001 module may be set from the Command Line Interface at any time, using the time command.

Section 3 Configuration

This Section explains how to configure an RX3i PROFINET Controller and its IO devices in a PACSystems RX3i controller system. Additional information about RX3i configuration is available in other PACSystems documentation and in the Logic Developer online help.

This Section discusses the following topics:

- Configuration Overview
 - Basic Configuration Steps
- Configuration Tools
- Configuring an RX3i PROFINET Controller
 - The PROFINET Controller's LAN
 - Configuring PROFINET Controller Parameters
- Configuring PROFINET LANs
 - Configuring the LAN Properties
- Adding a VersaMax PROFINET Scanner to a LAN
 - Configuring VersaMax PNS Parameters
 - Adding VersaMax PNS Power Supplies
 - Adding VersaMax Modules to a Remote Node
 - Adding Power Supplies Between Modules
 - Configuring VersaMax Module Parameters
 - Configuring Analog Modules that have Jumpers
- Adding a Third-Party IO-Device to a LAN
 - Editing Third-Party IO-Device Parameters
 - Configuring Sub-modules of an IO-Device
- Viewing / Editing IO-Device Properties
- Assigning IO-Device Names
- Configuring IO-Devices
- After the Configuration is Stored to the RX3i CPU
 - Configuring the RX3i Controller Configuration

3.1 Configuration Overview

The PAC Machine Edition PLC Logic Developer programmer is used to create and download the configuration for an RX3i PROFINET network and its devices.

3.1.1 System Planning

Device Ownership

Note that all modules in an IO Device must belong to the same PROFINET network; that is, they are all owned by the same PROFINET Controller. I/O modules within an IO-Device cannot be split between PROFINET Controllers.

PROFINET Controller Loading Limits

To prevent overloading of the PROFINET Controller, the maximum number of IO Devices that can be configured is limited, per the table below. Note that the loading threshold is different for embedded PROFINET Controllers (in the CPL410, CPE400, CPE330, CPE205/210/215/220/240 and CPE100/CPE115) than in the rack-mounted IC695PNC001. The PROFINET Controller loading limits are enforced by PAC Machine Edition.

Devices configured with longer update periods present smaller data loads to the PROFINET Controller. For example, a device with an update rate of 2ms presents a load equivalent to that of two devices at 4ms.

Maximum Configuration at Each Update Rate

The maximum number of devices allowed is determined by their update rates as shown in the following calculations:

PNC001	$SUM \left(\frac{\text{Number of Devices at Update Rate } x}{\text{Update Rate } x} \right) \leq 8 \text{ devices/ms}$
CPE400, CPL410, CPE330 & CPE205/210/215/220/240	$SUM \left(\frac{\text{Number of Devices at Update Rate } x}{\text{Update Rate } x} \right) \leq 2 \text{ devices/ms}$

Update Rate (x) per Device (ms)	Total Number of Devices per PNC001	Total Number of Devices per Embedded PROFINET IO Controller					
		CPE400 CPE330	CPL410	CPE100 CPE115	CPE205	CPE210 CPE215	CPE220 CPE240
1	8	2	2	0	2	2	2
2	16	4	4	0	4	4	4
4	32	8	8	0	8	8	8
8	64	16	16	0	8	16	16
16 – 512	128 (total device limit)	32	64	8	8	16	32
32 - 512	128 (total device limit)	32	64	8	8	16	32

In the case of PNC001, if the configuration exceeds the equivalent of eight devices with 1ms update rates, Machine Edition will not store the configuration.

For the embedded PROFINET Controllers in the above table have configurations that exceed the equivalent of two devices with 1ms update rates, Machine Edition will not store the configuration.

For the embedded PROFINET Controller CPE100/CPE115, it is not recommended to use Update Rates below 16ms even though it is configurable using Machine Edition.

3.1.2 Basic Configuration Steps

The basic configuration steps, described in this chapter, are:

- In the hardware configuration, configure LAN2 as an embedded PROFINET LAN, or, for slot-mounted hardware, add a PNC001 module to the RX3i main rack. This automatically associates a LAN with the PROFINET Controller.
- Configure the parameters of the PROFINET Controller itself.
- Select the PROFINET Controller and add IO-Devices to its LAN. These IO-Devices can be VersaMax PNS modules or third-party IO-Devices. Third-party IO-Devices and VersaMax PNS modules use GSDML files to describe their capabilities. PAC Machine Edition imports these GSDML files and incorporates the devices into the configuration.
- Configure the parameters of the VersaMax PNS modules and third-party IO Devices.
- Using the Machine Edition Inspector pane, configure the communications properties of the PROFINET Controller and any attached RX3i PNS modules, VersaMax PNS modules, and/or third-party IO Devices.
- Add supported RX3i modules to the RX3i PNS remote nodes.
- Add supported VersaMax modules to the VersaMax PNS remote nodes.
- Configure the parameters of the RX3i I/O modules, VersaMax I/O modules and third-party sub-modules in the remote nodes.
- When the configuration is ready, use the Discovery and Configuration Protocol (DCP) tool in Machine Edition to assign a Device Name to each IO-Device so the PROFINET Controller can connect to the devices and deliver their configuration.
- Store the configuration data from the programmer to the RX3i CPU.

Configuration Notes for Slot-Mounted PNC001

In the PAC Machine Edition hardware configuration, add a PNC001 to the RX3i main rack. This automatically creates a LAN for the PNC001.

Configuration Notes for Embedded PROFINET IO-Controller

When LAN2 is configured for Ethernet, the corresponding ports support SRTP Client/Server, Modbus TCP Client/Server, OPC UA Server, and EGD. All PROFINET controller services (Including Explore PROFINET Networks) are disabled when LAN2 is configured for Ethernet.

Configuring LAN2 for PROFINET retains standard Ethernet operation and enables PROFINET controller services.

3.2 Configuration Tools

PAC Machine Edition is the primary tool used to configure an RX3i PROFINET network. In addition, for the PNC001 module only, certain parameters can be set from a computer through the Command Line Interface (CLI).

The Command Line Interface can be used to set the non-volatile parameters in the PNC001-Ax module, as listed below. These parameters are initially set up in the PAC Machine Edition configuration. If any of these parameters is subsequently changed using CLI, the PNC001 module uses the new setting. Regardless of their source, the PNC001 module retains these settings in non-volatile memory, thus ensuring they can be re-asserted following a power cycle.

3.2.1 Non-Volatile Configuration Parameters

Parameter	Description	Default Value
IP Address	IP Address of the PNC001.	0.0.0.0
Subnet Mask	Subnet mask of the PNC001.	0.0.0.0
Default Gateway	Default Gateway for the PNC001.	0.0.0.0
Device Name	PNC001's PROFINET <i>Device Name</i> . Defaults to empty string - indicating the PNC001 is not named.	""
Redundant Media Role	Specifies whether media redundancy is disabled, if it is enabled as a Client, or if it is enabled as a Manager.	Disabled
Redundant Media Ring Port 1 ID	Indicates one of the two network ports involved in Media Redundancy. Valid values are 1 to 4.	1
Redundant Media Ring Port 2 ID	Indicates one of the two network ports involved in Media Redundancy. Valid values are 1 to 4.	2
Redundant Media test interval	Interval for sending test frames on ring ports in millisecond units. Valid values are 1 to 1000 ms.	20 ms
Redundant Media monitor count	Indicates the number of consecutive failed test frames before declaring a ring failure. Valid values are 2 to 10.	3

3.3 Configuring an RX3i PROFINET Controller

3.3.1 Configuring a Rack-Mounted RX3i PROFINET Controller (PNC001)

The PNC001-Bxxx is backward compatible with the PNC001-Ax. No hardware configuration changes to an existing application are required when replacing a PNC001-Ax with a PNC001-Bxxx. The PNC001-Bxxx has a lower power consumption than a -Ax . Therefore, new applications should use the PNC001-Bxxx hardware configuration so that PME's power calculation is more accurate. Use of the PNC011-Bxxx also provides customers access to future upgrades as features are added to the PNC001-Bxxx.

This section describes one technique to configure the parameters of an RX3i IC695PNC001. The PAC Machine Edition InfoViewer describes alternative menus and keyboard operations that can be used to perform the same functions.

1. In the Project tab of the Navigator, expand the PACSystems Target, the hardware configuration, and the main rack (Rack 0).
2. Right-click an empty slot and choose Add Module. The Module Catalog opens
3. Open the Bus Controller tab, select the IC695PNC001 module and click OK.
4. The PNC001 is displayed as having been placed in the selected rack/slot location.
 - Its parameters appear in the Parameter Editor window.
 - Its communications properties appear in the Inspector pane.
 - Edit the PNC001's parameters and its communications properties as described in this chapter.

Figure 33: RX3i Configuration showing PNC001 slot location

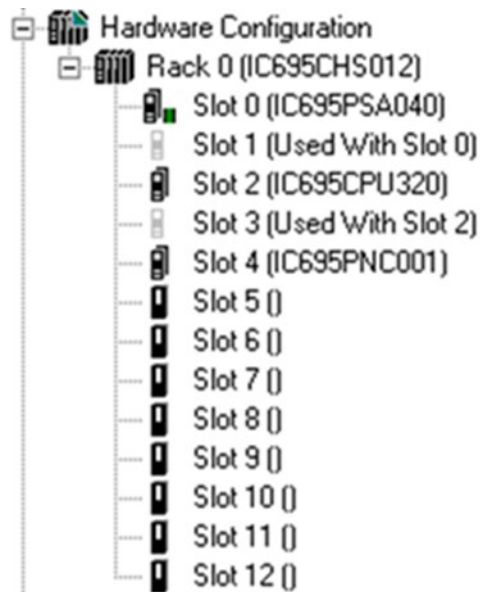

3.3.2 Configuring an Embedded RX3i PROFINET Controller

CPL410, CPE400, and CPE330 support configuring LAN2 as an embedded PROFINET Controller. Instead of Configuring a PNC001 into a rack/slot location (Figure 33), LAN2 in the target is configured as a PROFINET Controller (Figure 34).

Figure 34: Embedded PROFINET Controller Configured on LAN2

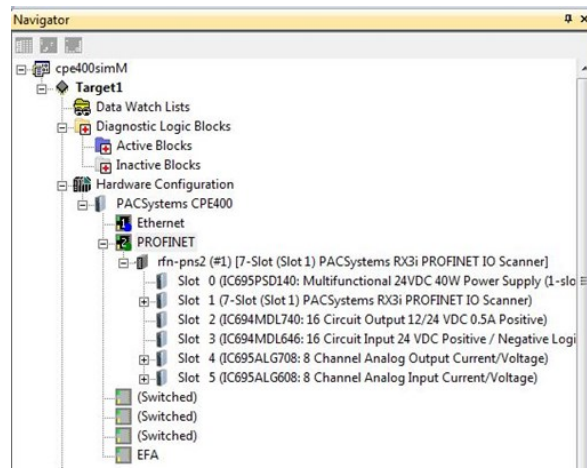

3.3.3 Configuring an Embedded RSTi-EP PROFINET Controller

RSTi-EP controllers support configurations of LAN2 as an embedded PROFINET Controller. Instead of Configuring a PNC001 into a rack/slot location (Figure 33). LAN2 in the target is configured as a PROFINET Controller (Figure 35).

Figure 35: Example of CPE100/CPE115 Embedded PROFINET Controller Configured on LAN2

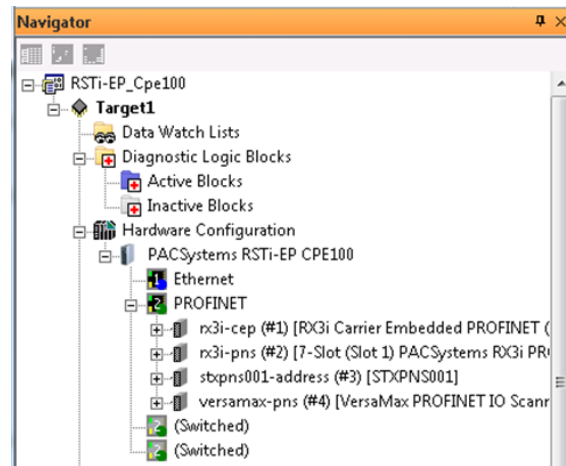

Note: EPXCPE controllers are similarly configured. The figure above is for demonstrative purposes.

3.5 Configuring PROFINET System Redundancy

To enable PROFINET System Redundancy in a CPL410/CPE400 project, select the CPL410/CPE400 target in the PAC Machine Edition Navigator and use the Property Inspector to change the Enable Redundancy target property to True.

To enable PROFINET System Redundancy in a CPE330 project, select the CPE330 target in the PAC Machine Edition Navigator and use the Property Inspector to change the Enable Redundancy target property to True. The Dual HWC property then defaults to True and must remain True.

To enable PROFINET System Redundancy for a PNC001, select the CPE330 or CRU320 target in the PAC Machine Edition Navigator and use the Property Inspector to change the Enable Redundancy target property to True. The Dual HWC property then defaults to True and must remain True.

Figure 36: Setting PROFINET System Redundancy Parameters in PAC Machine Edition Inspector

Inspector	
Target	
Name	Target1
Type	Controller
Description	
Documentation Address	
Family	PACSystems PDC3
Controller Target Name	cpustest1
Update Rate (ms)	250
Sweep Time (ms)	Offline
Controller Status	Offline
Dual HWC	True
Selected HWC	Primary
Scheduling Mode	Normal
Force Compact PVT	True
Genius Output	Error
Enable Shared Variables	False
Process System Enabled	False
DLB Heartbeat (ms)	1000
Enhanced Security	False
Compression Level	Normal
Enable Redundancy	True
Physical Port	ETHERNET
IP Address	192.168.0.100
Additional Configuration	

CPE205/210/215/220/240 and CPE100/CPE115 do not support PROFINET System Redundancy.

Note: For LED behavior and operator-initiated Role Switching in Hot Standby Systems, refer to the Quick Start Guide or product manual of the device itself. These topics are not covered in this manual.

3.6 Exploring PROFINET Networks

To explore the PROFINET networks in the system while PAC Machine Edition is online with the RX3i system, and while the PROFINET Controller is connected to its network, right-click on the Target icon (not the PNC) and select Explore PROFINET Networks under the Online Commands menu item.

The Explorer view shows version information about all the devices on the associated network. Figure 37 shows a PNC001 (located in Slot 6 of its CPU rack) with a single VersaMax PNS on its network. Figure 38 shows an embedded PROFINET Controller (embedded in a CPE330 / CPE400 / CPL410 / CPE205/210/215/220/240 / CPE100/CPE115) connected to an RX3i PNS module.

Note that all modules physically present in the remote nodes controlled by the PNS are displayed, regardless of whether the devices are configured or not.

Figure 37: Explore PROFINET Network from PNC001

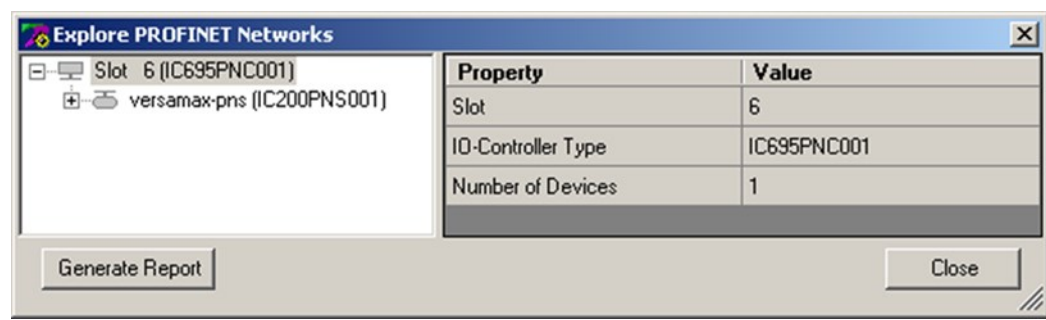
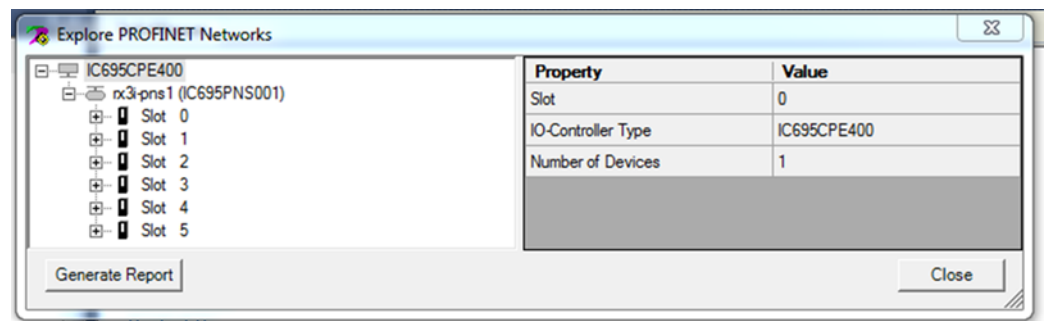

Figure 38: Explore PROFINET Network from Embedded PROFINET Controller



3.6.1 Configuring a PROFINET Controller on a LAN

Adding the first PROFINET Controller to a project automatically creates a LAN associated with it. For each subsequent PROFINET Controller that is added to a project, an existing LAN can be selected, or a new LAN can be created. Opening the LAN View shows PROFINET Controllers on their assigned LANs (To view the LANs in the project, click Tools in the Machine Edition toolbar, and select LAN View, or right-click).

Figure 39: LAN View showing PROFINET Controller on LAN2

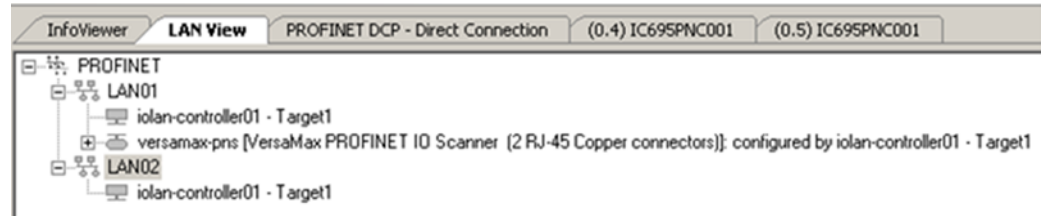

A PROFINET Controller can be moved to a different LAN by selecting the module in the Navigator and dragging it to the target LAN. Here, the PROFINET Controller has been moved from LAN02 (Figure 39) to LAN01 (Figure 40):

Figure 40: LAN View showing PROFINET Controller on LAN1

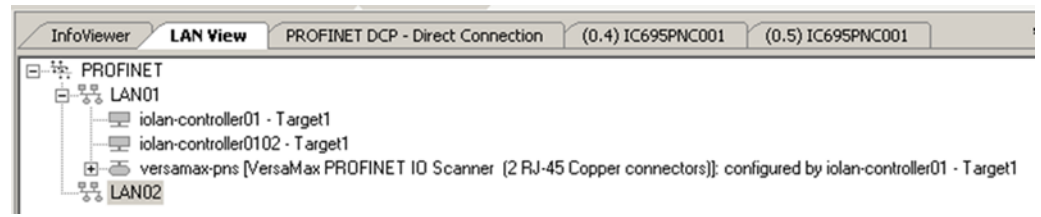

3.6.2 Configuring PROFINET Controller Parameters

Configure the PROFINET Controller parameters by editing the tabs as appropriate. The parameters are divided among the tabs, and the options are available in the Inspector view.

PROFINET Controller Parameters (Settings Tab)

Figure 41: PROFINET Controller Settings Tab (PNC001)

Settings Media Redundancy Power Consumption	
Parameters	Values
Status Address	%I00081
Length	32
SFP Cage 1	Used by Built-in Port
SFP Cage 2	Used by Built-in Port
SFP Cage 3	1000BASE-SX
SFP Cage 4	1000BASE-SX
I/O Scan Set	1
Network Port 1 Critical	False
Network Port 2 Critical	False <small>Choice List: False, True</small>
Network Port 3 Critical	False
Network Port 4 Critical	False

Figure 42: PROFINET Controller Settings Tab (Embedded PNC)

InfoViewer (0.0.1) PROFINET [Target1] (0.2) IC695CPU320 [Target2] (0.4)	
Settings Media Redundancy	
Parameters	Values
Status Address	%I00081
Length	32
I/O Scan Set	1
Network Port 1 Critical	False
Network Port 2 Critical	False

Note that the embedded PROFINET Controller does not have any SFP cages, and therefore has options for two ports, versus the four ports available in the PNC001.

Status Address, Length: The Status Address is the reference memory location for the 32 bits of status data associated with the PROFINET Controller itself. The Status address can be assigned to valid %I, %Q, %R, %AI, %AQ, %W, %G, %T or %M memory by right-clicking on the Status Address field and selecting the Data Entry tool. The default value is the next available %I address. See Section 5 Diagnostics, for definitions of the status bits that the module writes to this address.

Figure 43: Setting the Status Reference Address

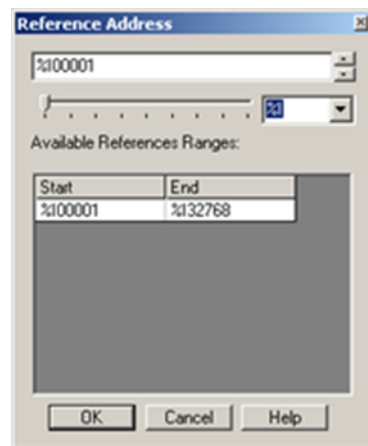

Note: Because point faults are not supported by %G, %T and %M, the other available memory types, or I/O Symbolic, are preferred.

SFP Cage 1 / 2 / 3 / 4: If the PNC001 module will use plug-in Small Form-factor Pluggable devices in Port 3 and/or Port 4, specify the SFP devices in the appropriate field(s). On the Settings tab, right-click in the Values field for the port, and select Data Entry tool to open the Catalog window. In the Catalog window, select the type of SFP device for the port, as shown in Figure 44, and click OK. If the device is not listed, choose GENERIC_SFP to add it to the configuration.

Figure 44: Select SFP Device from Catalog

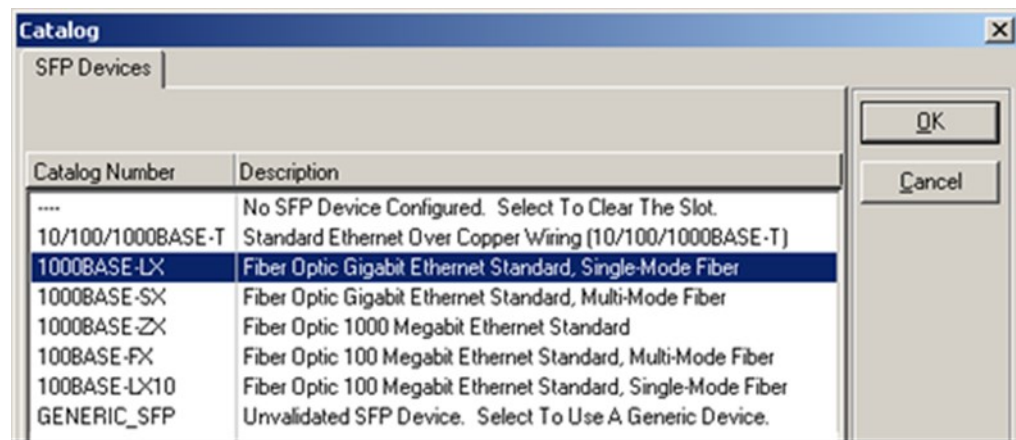

I/O Scan Set: The scan set for the PROFINET Controller defaults to scan set 1. Scan sets are defined in the CPU's Scan Sets tab. The valid range is 1 through 32; the default value is 1. Refer to the *PACSystems RX7i and RX3i CPU Reference Manual*, GFK-2222, for a discussion of CPU scan sets.

The embedded PROFINET Controllers and the PNC001 behave the same as far as this parameter is concerned.

Critical Network Ports: The default critical network port setting for all PROFINET Controller ports is False. Setting one or more network ports on the PROFINET Controller as a critical network port provides for triggering a CPU redundancy role switch when the last of all the critical network port links associated with that PROFINET Controller are lost (disconnected). Basically, when the last critical network port is disconnected from its network, a diagnostic fault is logged by the PROFINET Controller. In a redundancy system, where the PROFINET Controller is controlling redundant devices, this results in a fatal IOC Software Fault and a Hot Standby CPU redundancy role switch with the CPU placed into Stop/Fault mode.

When using the critical network ports feature, the following PROFINET speeds are strongly recommended:

PROFINET Network Speed	Recommended Network Type
100 Mbps	Copper and/or Fiber based networks
1000 Mbps	Fiber based networks ONLY. Network ports 3 and 4 support fiber-based networks via the SFP interface

Copper-based networks are not recommended at 1000 Mbps due to the extremely slow link down detection associated with both fixed and SFP-based copper ports at this network speed. Using copper-based networks at 1000 Mbps may result in the loss of I/O Devices when the last critical network port is disconnected from the network. For this reason, the PROFINET Controller has a built-in feature that forces any Cu port (fixed or Cu SFP) that is configured as a critical port to 100M.

Note: *Critical network ports are allowed in simplex systems. However, the logging of the diagnostic fault, when the last of the critical network ports is disconnected, does not invoke any role switch, and does not place the CPU in Stop/Fault mode.*

When the critical port is enabled, the MRC undergoes an Ethernet port reset during the download of application logic, which causes the loss or addition of IO devices connected to it. However, after the loss or addition of devices, the operation resumes normally.

PROFINET Controller Parameters (Media Redundancy Tab)

By default, a PROFINET Controller is not set up for Media Redundancy. If the system will use Media Redundancy (see Section 6 for more information), open the Media Redundancy tab and select either Client or Manager:

Figure 45: Setting Media Redundancy Parameters

Settings Media Redundancy Power Consumption	
Parameters	Values
Media Redundancy	None
	None
	Client
	Manager

If the PROFINET Controller will be a Media Redundancy Client, click on Ring Port 1 and Ring Port 2 to choose the module ports and Domain Name that will be used.

Figure 46: Setting Media Redundancy Client Parameters

Parameters	Values
Media Redundancy	Client
Ring Port 1	1
Ring Port 2	1
Domain Name	2
	3
	4

If the PROFINET Controller will be a Media Redundancy Manager, edit the Ring Port settings as above. You can also change the Default Test Interval in the range of 10 to 1000ms and the Test Monitoring Count (2 to 10). For the Media Redundancy Manager, the Domain Name can be edited by typing over the default name.

Figure 47: Setting Media Redundancy Manager Parameters

Parameters	Values
Media Redundancy	Manager
Ring Port 1	1
Ring Port 2	2
Default Test Interval (ms)	20
Test Monitoring Count	3
Domain Name	mrpdomain-1

Note:

- In an MRP ring with many clients, storing a configuration that causes all clients to reconfigure (for example, changing the Domain Name) may generate many Losses/Additions of Device faults. This is the expected behavior, and all devices should automatically return to operational status.
- If one of the module ports chosen as a Ring Port is configured as a critical network port, PAC Machine Edition automatically sets the other Ring Port as a critical network port.

3.8 Configuring PROFINET LANs

To view the LANs in the project, click on Tools in the Machine Edition toolbar, and select LAN View from the menu. If no LANs and no PROFINET Controllers have been added to the project, the LAN View is empty:

Figure 48: Configuring the PROFINET LAN

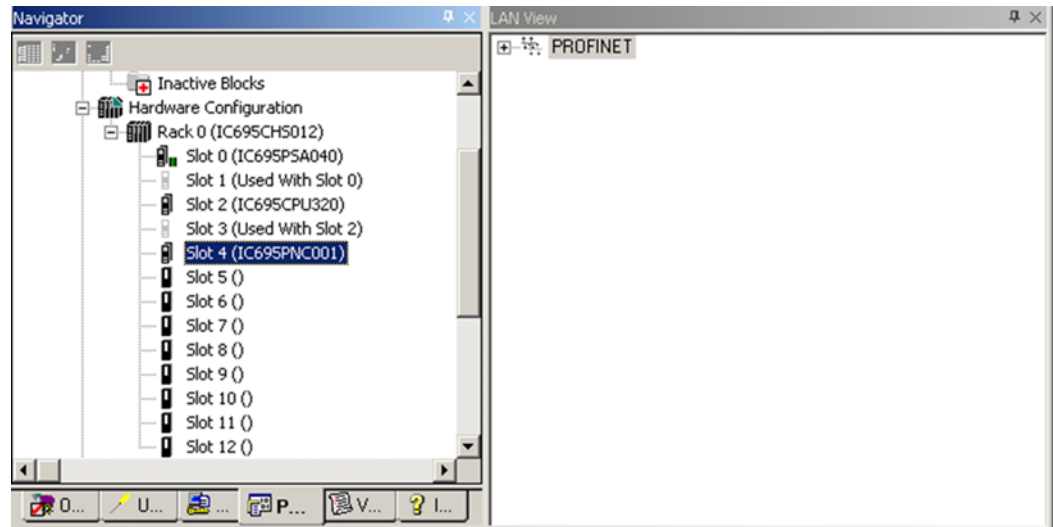

Adding a PROFINET Controller to the project automatically creates a new LAN.

Figure 49: LAN Associated with PROFINET Controller

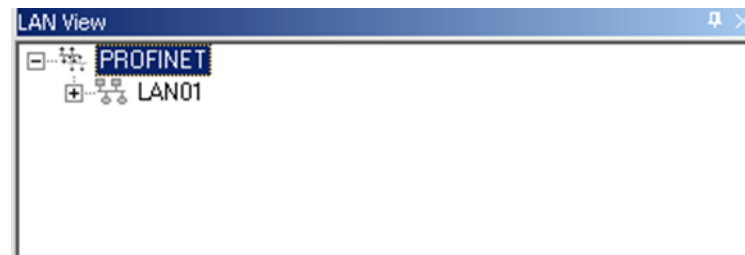

Expand the LAN icon in the LAN View to see the modules it includes.

A LAN can also be added to the project by right-clicking on the PROFINET icon in the LAN View and selecting Add LAN.

Figure 50: Adding a New LAN to the Configuration



3.8.2 Configuring the LAN Properties

Machine Edition automatically assigns a set of default properties to the LAN. Select the LAN icon in the LAN viewer to display or edit its communications properties in the Inspector pane:

Figure 51: Setting the Communication Properties of a LAN

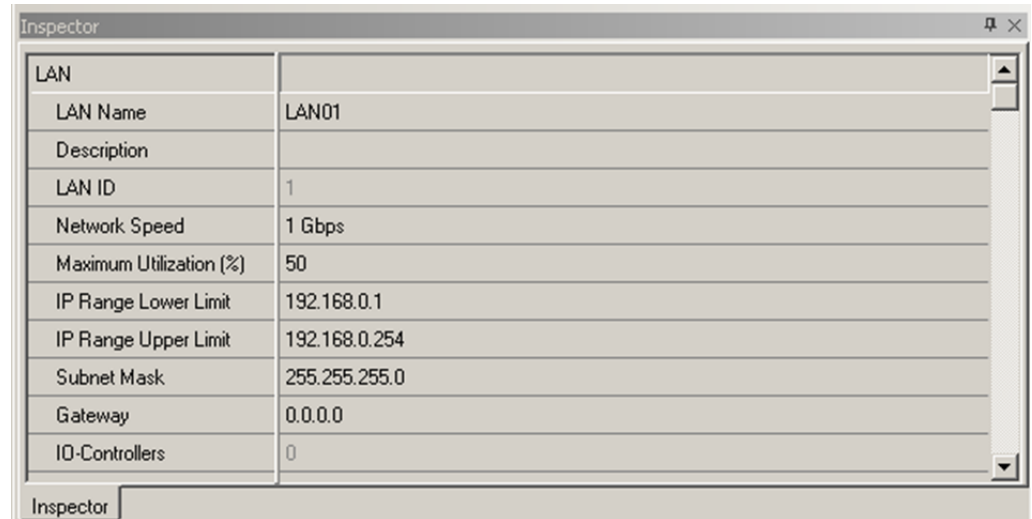

LAN Name: this can be edited, or the default name can be used. Space characters are not permitted.

Description: an optional description of up to 255 characters can be entered for the LAN.

LAN ID: (read-only) this number identifies the LAN in the Machine Edition project.

Network Speed: the bandwidth available on the network. The default of 1Gbps can be changed to 100Mbps.

Maximum Utilization (%): the maximum percentage of total network bandwidth that can be used for PROFINET I/O traffic. It can be edited to any value between 10 and 80 (do not enter the % character). Consider another network traffic when changing this parameter.

IP Range Lower Limit: the lowest IP Address for automatically assigning IP Addresses to PROFINET Controllers and LAN devices. Default is 192.168.x.1, where x is the lowest number not used by another LAN in the project.

IP Range Upper Limit: the highest IP Address for automatically assigning IP Addresses to PROFINET Controllers and LAN devices. Default is 192.168.x.254, where x is the lowest number not used by another LAN in the project.

⚠ CAUTION

If the subnet mask is improperly set, devices may be unable to communicate on the network and might disrupt network communications. Contact your network administrator to assign values that work with an existing network.

Subnet Mask: Mechanism that filters network communications so that they are routed only to subnets to which they are addressed. The value defined here propagates to PROFINET Controllers and I/O devices throughout the network.

PROFINET can only communicate to nodes in the local subnet. All nodes on the LAN must be in the same subnet. The IP Range Lower/Upper Limits indicate the auto-assignment range. The range of the LAN is the subnet mask range. A node can be assigned to any address in the subnet (which may be outside of the auto-assignment range given in the dialog), but the addresses for all nodes must be in the subnet.

Gateway: The IP Address of the device that connects two (sub)networks that use different communications protocols, enabling them to communicate with each other. The value defined here propagates to PROFINET Controllers and I/O devices throughout the network.

⚠ CAUTION

If the gateway is improperly set, devices may be unable to communicate on the network and might disrupt network communications. Contact your network administrator to assign values that work with an existing network.

IO-Controllers: (Read-only.) The number of I/O Controllers configured to reside on the LAN.

IO-Devices: (Read-only.) The number of I/O devices configured to reside on the LAN.

Network Transit Time⁷ (units of 1 ms): The maximum time (in ms) for a message to propagate between any two nodes on the LAN. This time depends upon the network architecture and is typically negligible. It can be significant in networks that have one or more slow segments.

For a media redundancy ring network, it is recommended to set this parameter to at least 5 ms (parameter value = 5), which accommodates the maximum supported number of ring nodes.

⁷ Versions of this manual (prior to version N), incorrectly dimensioned this unit in terms of tenths of a millisecond. The units are in ms.

3.9 Adding a VersaMax PROFINET Scanner to a LAN

To add a VersaMax PNS to a LAN, in the Navigator right-click on the IC695PNC001 module and select Add IO Device. The PROFINET Device Catalog appears.

Figure 52: Select PNS from Catalog

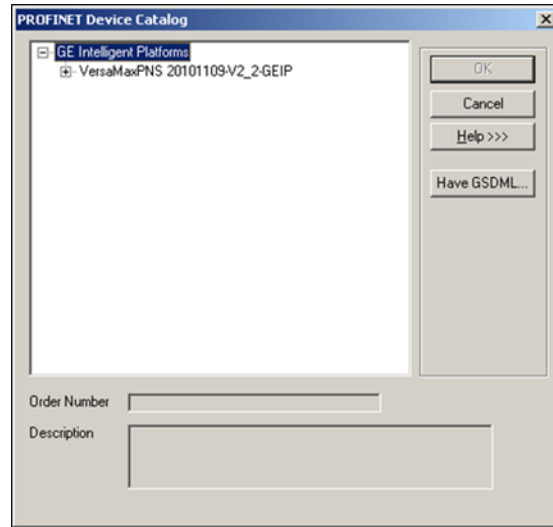

In the PROFINET Device Catalog, expand the VersaMax PNS line and choose the module type:

Figure 53: Select PNS Type

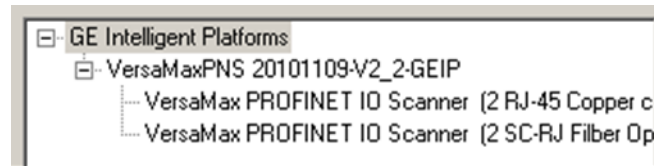

Select the PNS type and click OK. The PNS appears in the Navigator window:

Figure 54: PNS Attached to PNC001 in PAC MACHINE EDITION Navigator

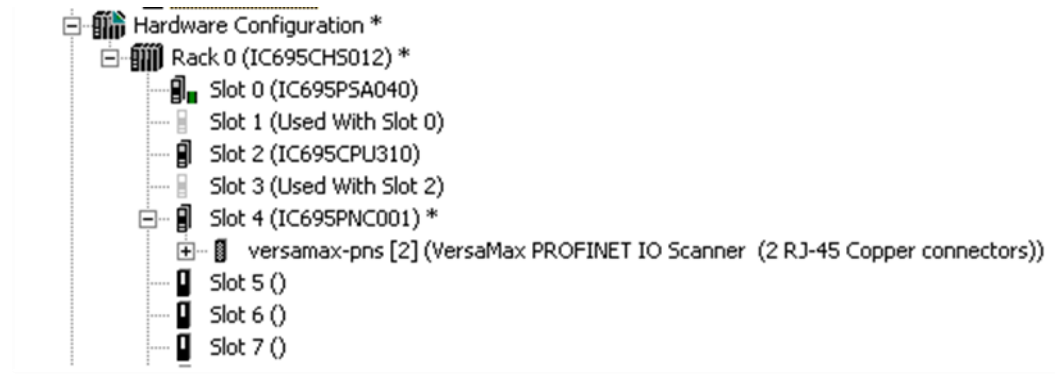

3.9.2 Configuring VersaMax PROFINET Scanner Parameters

After adding a VersaMax PNS to the LAN, its parameters can be configured by either double-clicking on the Scanner in the Navigator, or right-clicking and selecting Configure from the menu.

Figure 55: Select PNS for Parameter Configuration

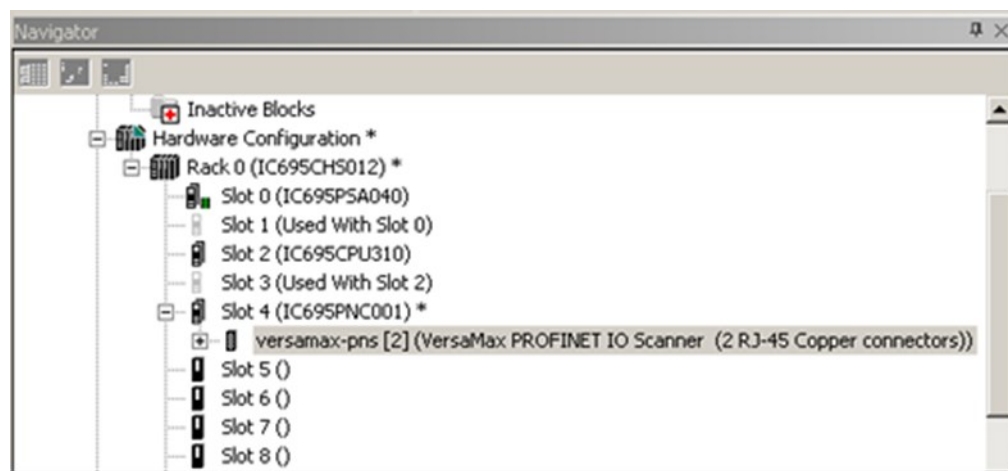

PROFINET Scanner Parameters (Settings Tab)

Figure 56: PNS Parameters Settings Tab

Settings Redundancy Media Redundancy Power Consumption Module Parameters GSDML Details	
Parameters	Values
Inputs Default	Force Off
Input Status	%I00049
Length	32
Output Status	%Q00049
Length	32
I/O Scan Set	1

Inputs Default: Choose whether the RX3i CPU will set inputs from any modules in the PNS module's remote node to Off or Hold Last State in the following cases:

- The PROFINET Controller is not operational or has been removed.
- The PROFINET Controller cannot communicate with the scanner due to cable or network configuration issues.
- The PNS is not able to scan the I/O module in its remote node.

Input Status and Length: The address in reference memory for the 32 bits of status data associated with the PNS. The address can be assigned to valid %G, %I, %Q, %T or %M memory or Symbolic bits. The default value is the next available %I address. Refer to the *VersaMax PROFINET Scanner Manual*, GFK 2721, for definitions of the PNS input status bits.

Output Status and Length: The address in reference memory for the 32 bits of output control data associated with the PNS. The address can be assigned to valid %G, %I, %Q, %T or %M memory or Symbolic bits. The default value is the next available %Q address. Refer to the *VersaMax PROFINET Scanner Manual*, GFK-2721, for definitions of the PNS output control bits.

I/O Scan Set: Specifies the I/O scan set to be assigned to the PNS. Scan sets are defined in the CPU's Scan Sets tab. The valid range is 1 through 32; the default value is 1.

PROFINET Scanner Parameters (Redundancy Tab)

On the Redundancy tab, select whether the PNS is redundantly controlled.

Figure 57: PNS Parameters Redundancy Tab

Settings		Redundancy	Media Redundancy	Power Consumption	Module Parameters	GSDML Details
Parameters	Values					
Redundancy Mode	HSB CPU Redundancy					
	None					
	HSB CPU Redundancy					

When the PNS supports PROFINET System Redundancy and is configured in an HSB CPU Redundancy system, the Programmer automatically selects redundant control by setting the Redundancy Mode parameter to HSB CPU Redundancy.

When the PNS does not support PROFINET System Redundancy, or is not configured in an HSB CPU Redundancy system, the PNS Programmer automatically selects simplex operation (non-redundant control) by setting the Redundancy Mode parameter to None.

To configure a redundancy-capable PNS for simplex operation within an HSB CPU Redundancy system, change the Redundancy Mode parameter on the Redundancy tab from HSB CPU Redundancy to None.

PROFINET Scanner Parameters (Media Redundancy Tab)

By default, the PNS is not set up for Media Redundancy. If the system will use Media Redundancy (see Section 6 Redundant Media, for more information), open the Media Redundancy tab and select Client.

Figure 58: PNS Parameters Media Redundancy Tab

Parameters	Values
Media Redundancy	Client
Ring Port 1	1
Ring Port 2	2
Domain Name	mipdomain-1

If the PNS will be a Media Redundancy Client, click on Ring Port 1 and Ring Port 2 to choose the module ports that will be used.

Figure 59: Select PNS Ring Ports Usage

Settings		Media Redundancy	Power Consumption	Module Parameters	GSDML Details
Parameters	Values				
Media Redundancy	Client				
Ring Port 1	1				
Ring Port 2	2				
Domain Name	1				
	2				

PROFINET Scanner Parameters (Module Parameters Tab)

The PNS has one module parameter:

Figure 60: PNS Parameters Module Parameters Tab

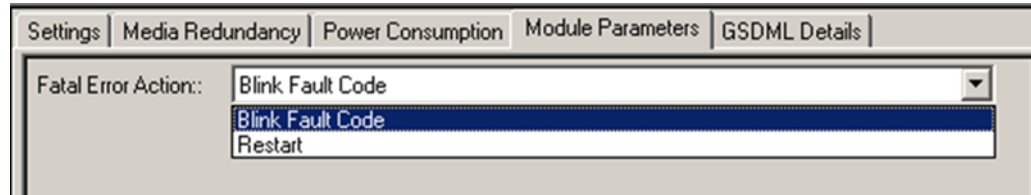

By default, the PNS module LEDs will blink a fault code if a fatal error occurs. This can be changed to cause the PNS to restart instead.

PROFINET Scanner Parameters (GSDML Tab)

The PNS module's GSDML Details tab displays the information from its GSDML file.

Figure 61: PNS Parameters GSDML Details Tab

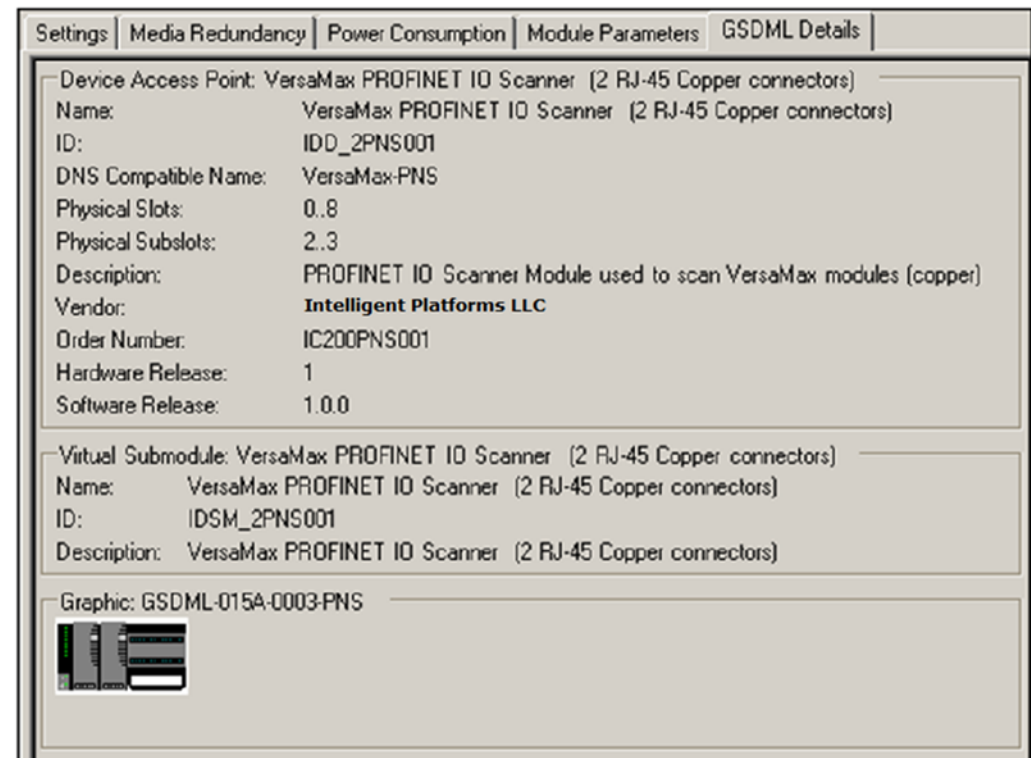

This information cannot be edited.

Double-clicking on the PNS module's Interface 1 icon in the Navigator displays additional GSDML parameters:

Figure 62: PNS Interface Parameter Details

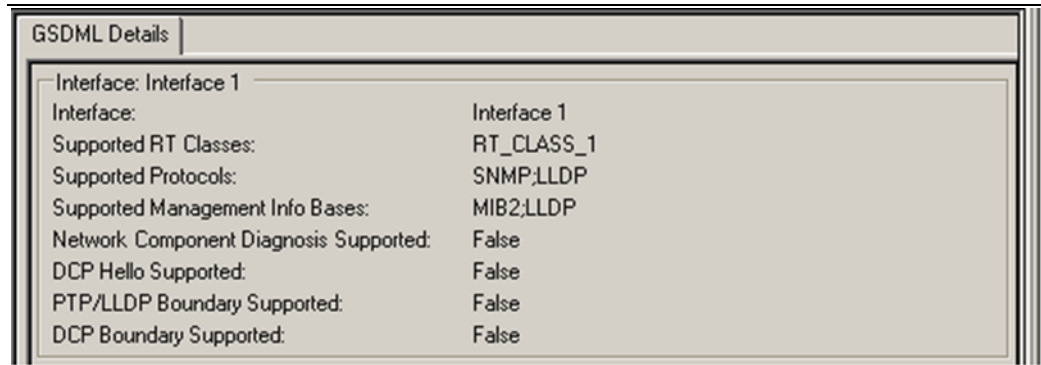

The screenshot shows a window titled "GSDML Details" with a sub-header "Interface: Interface 1". Below this, a table lists various parameters and their values.

Parameter	Value
Interface:	Interface 1
Supported RT Classes:	RT_CLASS_1
Supported Protocols:	SNMP;LLDP
Supported Management Info Bases:	MIB2;LLDP
Network Component Diagnosis Supported:	False
DCP Hello Supported:	False
PTP/LLDP Boundary Supported:	False
DCP Boundary Supported:	False

Double-clicking on the PNS module's Port 1 and Port 2 icons in the Navigator also displays additional GSDML parameters for the scanner:

Figure 63: PNS Port Parameter Details

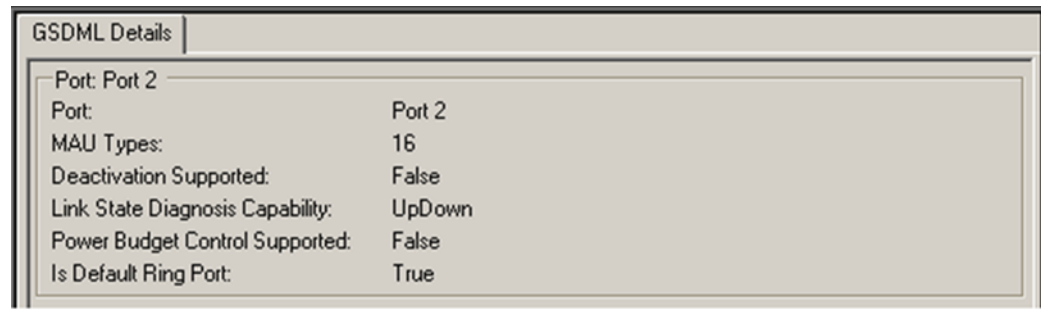

The screenshot shows a window titled "GSDML Details" with a sub-header "Port: Port 2". Below this, a table lists various parameters and their values.

Parameter	Value
Port:	Port 2
MAU Types:	16
Deactivation Supported:	False
Link State Diagnosis Capability:	UpDown
Power Budget Control Supported:	False
Is Default Ring Port:	True

3.9.4 Adding VersaMax PROFINET Scanner Power Supplies

The VersaMax PNS has connectors for either one or two power supplies. If necessary, additional power supplies can also be located between modules in the remote node.

To configure the one or two power supplies that will be installed directly on the PNS module, right-click on the Slot 0 icon in the Navigator, then select Change Submodule List. A list of VersaMax power supplies appears.

In the Submodule list for slot 0, expand the Power Supply list and select the desired power supply from the list. Drag the selected power supply to an available slot in the left pane. Slot 0, Subslot 2 is the leftmost power supply slot. Slot 0, Subslot 3 is the rightmost power supply slot (To delete a module after moving it, select the module on the left and press the keyboard Delete key).

Figure 64: Selecting Power Supply for PNS Rack

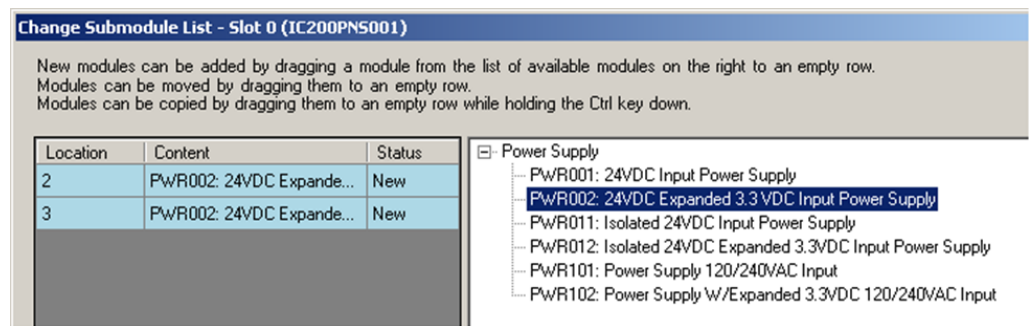

Click OK to add the selected module(s) to the configuration. The Navigator shows the added power supply or power supplies under slot 0.

Figure 65: Power Supplies Displayed in PNS Rack

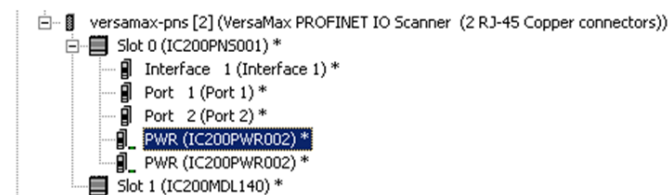

Adding power supplies to the configuration sets up power supply alarms. Alarms will be triggered if the power supply is configured but not working or configured in the wrong subslot. These power supplies have no configurable parameters, but their power supply and GSDML details can be viewed by double-clicking on a power supply icon or right-clicking and selecting Configure.

3.9.6 Adding VersaMax Modules to a Remote Node

The PNS remote node can contain the module types listed in the *VersaMax PROFINET Scanner Manual*, GFK 2721. However, it cannot contain the following expansion modules or communications modules:

Unsupported VersaMax Modules	
Asi Network Master Module	IC200BEM104
Device Net Network Control Module	IC200BEM103
Expansion Transmitter Module	IC200ETM001
Expansion Receiver Module, Isolated	IC200ERM001
Expansion Receiver Module, Non-isolated	IC200ERM002
Profibus-DP Network Slave Module	IC200BEM002

To add a module to the remote node, right click on the VersaMax PNS icon in the Navigator and select Change Module List. In the right pane of the Change Module List window, expand the list of VersaMax module types.

Figure 66: Adding VersaMax I/O Modules to Remote Node

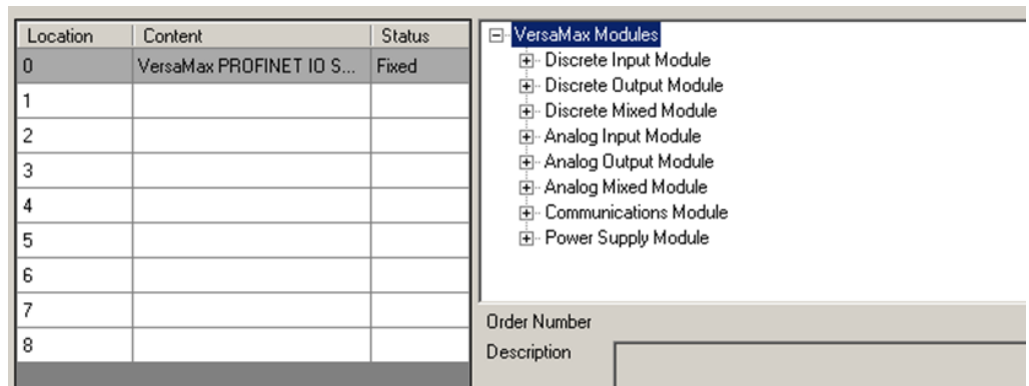

Select modules from the list (right pane) and drag them to available slot locations in the remote node (left pane).

Figure 67: Select VersaMax Module from Available List

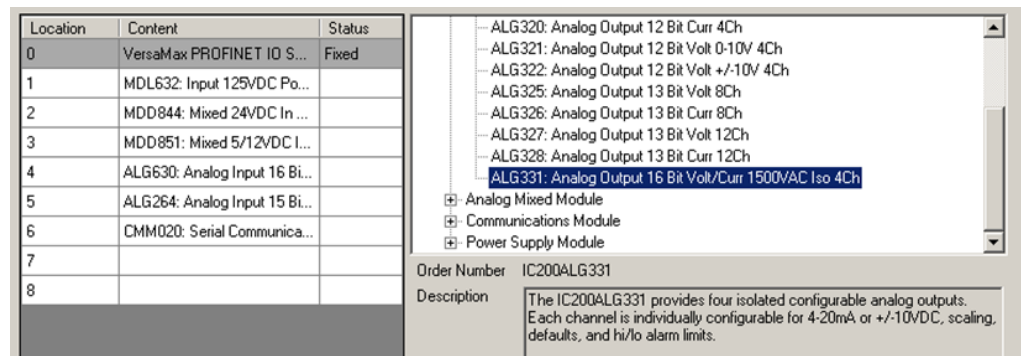

To delete a module from the left-side pane, select it and press the keyboard Delete key. When the modules in the left side pane are correctly situated, click OK to add them to the Configuration.

3.9.7 Installing Power Supplies Between Modules

Additional power supplies may be installed between modules, if necessary. Power Supply modules added in this fashion will service the power requirements of modules located further right in the same rack.

To add a power supply between modules, expand the Power Supply Module node in the Change Module List. Select the desired power supply from the list. When you drag the power supply to the left pane, additional rows labeled power appear between the previously listed modules. Drop the power supply into its intended location.

Figure 68: Adding Power Supplies between Modules in PNS Rack

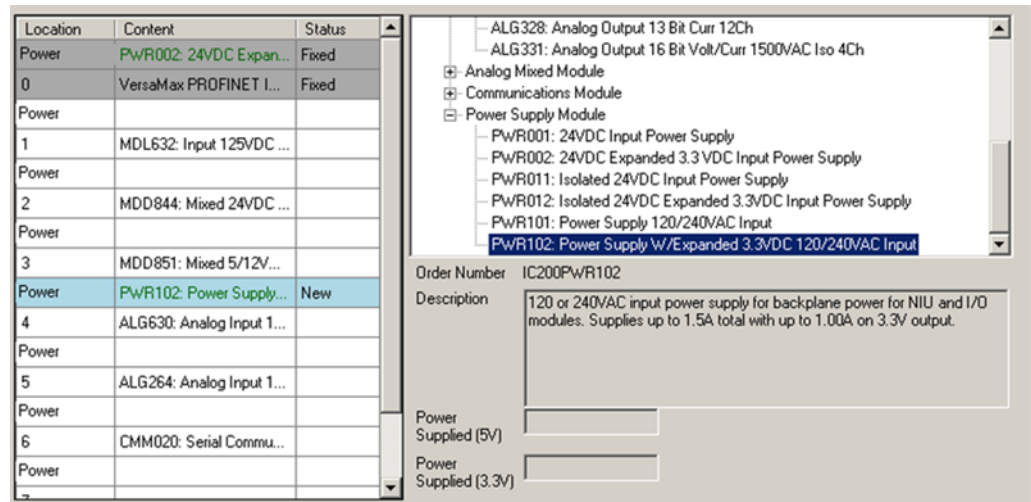

Click OK to add the module(s) to the Configuration.

Figure 69: VersaMax PNS Rack showing Power Supply Located between I/O Modules

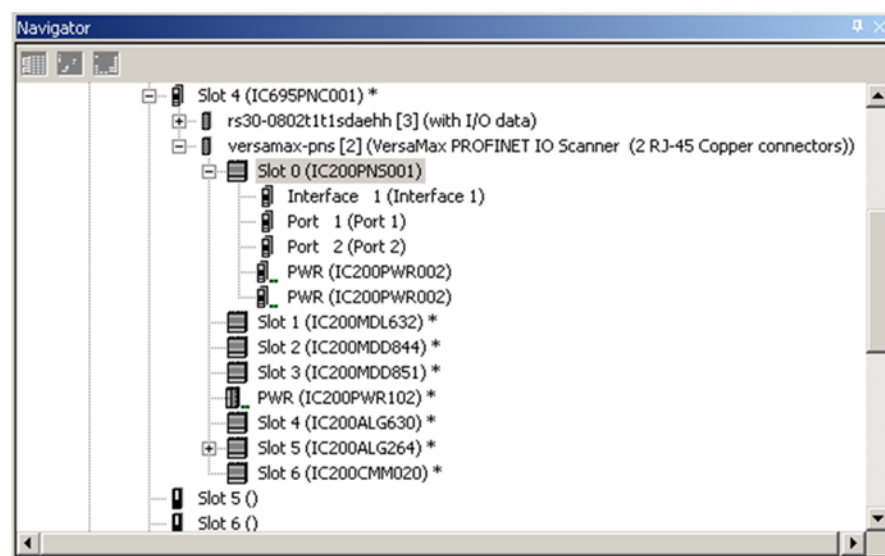

3.9.8 Configuring VersaMax Module Parameters

After adding VersaMax modules to the remote node, the parameters for each must be configured. For all VersaMax modules, this includes configuring a set of basic parameters (such as: Reference Address, Length, Scan Set, Carrier, Report Faults). Configuration details for those basic parameters are provided in the Configuration Section of the *VersaMax PROFINET Scanner Manual*, GFK 2721.

Configuring Analog Modules Requiring Jumper Settings

The following VersaMax analog modules use jumpers to select their voltage / current operation or output defaults mode.

CAT Number	Description
IC200ALG230	Analog Input Module, 12-bit Voltage/Current 4 Channels
IC200ALG260	Analog Input Module, 12-bit Voltage/Current 8 Channels
IC200ALG262	Analog Input Module, 15-bit Current Differential 8 Channels
IC200ALG264	Analog Input Module, 15-bit Current 15 Channels
IC200ALG266	Analog Input 15-bit Current 15Ch with enhanced over voltage protection
IC200ALG320	Analog Output Module, 12-bit Current, 4 Channels
IC200ALG321	Analog Output Module, 12-bit Voltage 4 Channels. 0 to +10Vdc Range
IC200ALG322	Analog Output Module, 12-bit Voltage 4 Channels. -10 to +10Vdc Range
IC200ALG325	Analog Output Module, 13-bit Voltage 8 Channels
IC200ALG326	Analog Output Module, 13-bit Current 8 Channels
IC200ALG327	Analog Output Module, 13-bit Voltage 12 Channels
IC200ALG328	Analog Output Module, 13-bit Current 12 Channels

CAT Number	Description
IC200ALG430	Analog Mixed Module, Input Current 4 Channels, Output Current 2 Channels
IC200ALG431	Analog Mixed Module, 0 to +10Vdc Input 4 Channels, Output 0 to +10Vdc 2 Channels
IC200ALG432	Analog Mixed Module, 12-bit -10 to +10Vdc, Input 4 Channels / Output -10 to +10Vdc 2 Channels

All VersaMax Analog modules, except MDD841 and ALG331, support a default Analog value of zero only.

Before their parameters can be configured, these modules require an additional configuration step in Machine Edition after being added to the PNS remote node.

When one of the above modules is added to the Configuration, the Navigator window shows a Configuration Mismatch for the module (and for its PNS). This situation needs to be resolved before continuing, as described in below Section.

Figure 70 shows a configuration in which two modules have this type of mismatch:

Figure 70: Analog Modules Requiring Jumper-Setting Designation

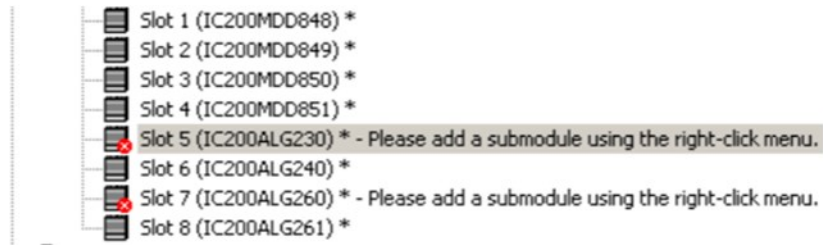

Double-clicking one of these modules, or right-clicking and selecting Configure displays only the Power Consumption and GSDML tabs. The Settings tab and other configuration tabs do not appear. To begin configuring one of these modules, right-click the module in the Navigator and select Change Submodule List from the menu.

The Change Submodule List

On the Change Submodule List, select the type of inputs or outputs that will be wired to the module, and drag the selection to the Content field in the left pane. For example:

Figure 71: Selecting the Sub-Module Configuration with Jumper Settings Declared

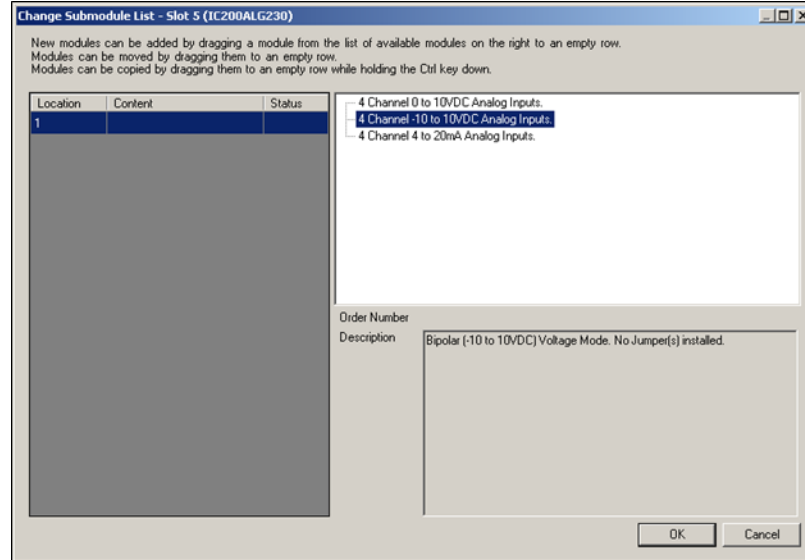

Once the Content field has been populated, the Description field indicates how the physical jumpers in the module should be configured. The +10 Vdc analog inputs selected in Figure 71 do not require the installation of jumpers on the module. If selected, the other choices for this module would require jumpers. It is important to ensure that the jumper installation matches the configuration for that module in PAC MACHINE EDITION. In the event the jumper settings need to be altered due to changing channel requirements, the module configuration in PAC MACHINE EDITION should be changed to match by retracing the steps outlined in this section.

After choosing the submodule parameters of the module as described above, a subslot appears in the Navigator, and the module's Configuration Mismatch is cleared:

Figure 72: Analog Modules Showing Configuration Mismatch Cleared

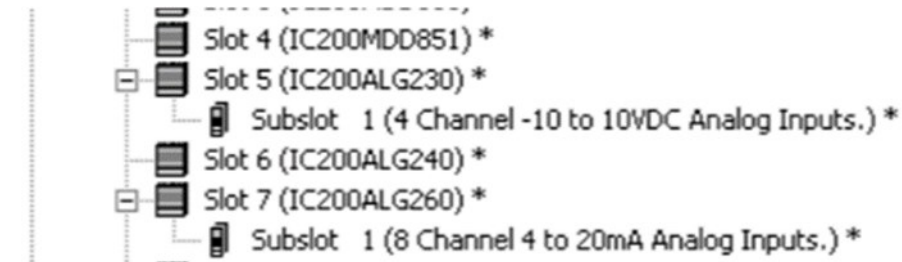

Configuring the Module Parameters

Double-click the subslot (not the module slot) in the Navigator to configure the module parameters. The remaining configuration steps for these modules is the same as for other VersaMax modules.

For a list of VersaMax Analog module subslot configuration choices and jumper settings, refer to Configuring Analog Modules that Have Jumpers in the *VersaMax PROFINET Scanner Manual*, GFK-2721.

3.10 Adding a Third-Party IO-Device to a LAN

To add a third-party IO-Device to a LAN, in the Navigator right-click on the connected IC695PNC001 module and select Add IO-Device. Select the module in the PROFINET Device Catalog and click Have GSDML:

Figure 73: Selecting Third-Party Modules for Addition to LAN

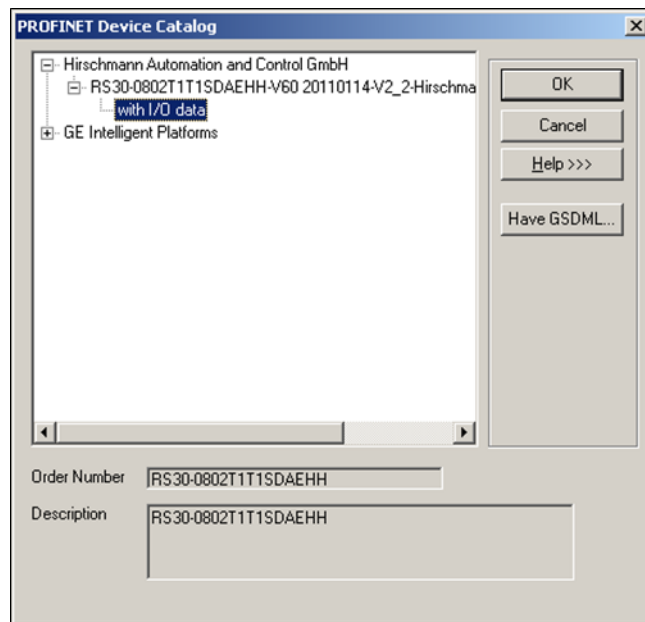

To be included in the system configuration, any third-party IO-Device requires a GSDML file. The GSDML file for the device must be present on the computer being used for the configuration.

Figure 74: Finding GSDML File for Third-Party Device

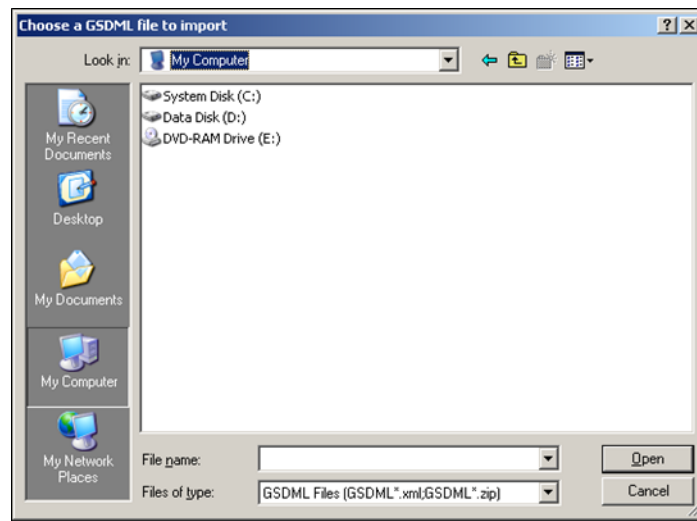

Provide a filename path to the file and click OK. The device is added to the configuration. Machine Edition extracts necessary parameters from the GSDML file and makes the data available for editing within Machine Edition.

3.10.1 Editing Third-Party IO-Device Parameters

To configure the parameters of a third-party IO-Device, either double-click on the module in the Navigator, or right-click on the module and select Configure from the menu. Upon opening the IO Devices configuration, you will see an IO-Device Access Point tab, a GSDML Details tab, and, possibly, additional parameter tabs (if defined by the device manufacturer in the associated GSDML file).

IO-Device Parameters (IO-Device Access Point Tab)

Use the IO-Device Access Point tab to set up the device's interface to the RX3i controller:

Figure 75: Third-Party I/O: Use of IO-Device Access Point Tab

IO-Device Access Point		Media Redundancy	Device parameters	Device status	GSDML Details
Parameters	Values				
Inputs Default	Force Off				
I/O Scan Set	1				

Inputs Default: Choose whether the RX3i CPU will set inputs from the remote node to Off, or Hold Last State in the following cases:

- The PROFINET Controller is not operational or is removed.
- The PROFINET Controller cannot communicate with the device due to cable or network configuration issues.
- The device is not able to scan the sub-module in its remote node.

I/O Scan Set: The scan set for an IO-Device defaults to scan set 1. Scan sets are defined in the associated PLC CPU's Scan Sets tab. The valid range is 1 through 32; the default value is 1.

IO-Device Parameters (Media Redundancy Tab)

If the IO-Device supports Media Redundancy (see Section 6 Redundant Media, for more information), a Media Redundancy tab will be present. Open the Media Redundancy tab and select either Client or Manager:

Figure 76: Third-Party I/O: Use of Media Redundancy Tab

IO-Device Access Point		Media Redundancy	Device parameters	Device status	GSDML Details
Parameters	Values				
Media Redundancy	Client				
Ring Port 1	1				
Ring Port 2	2				
Domain Name	mrpdomain-1				

If the IO-Device will be a Media Redundancy Client, click on *Ring Port 1* and *Ring Port 2* to choose the module ports that will be used.

Figure 77: Third-Party I/O: Select Ring Ports for Media Redundancy Client

Parameters	Values
Media Redundancy	Client
Ring Port 1	1
Ring Port 2	1
Domain Name	2
	3
	4

If the IO-Device will be a Media Redundancy Manager, edit the Ring Port settings as above. You can also change the Default Test Interval in the range of 1 to 1000ms and the Test Monitoring Count (2 to 10). For the Media Redundancy Manager, the Domain Name can be edited by typing over the default name.

Figure 78: Third-Party I/O: Configure Ring Ports for Media Redundancy Manager

Parameters	Values
Media Redundancy	Manager
Ring Port 1	1
Ring Port 2	2
Default Test Interval (ms)	20
Test Monitoring Count	3
Domain Name	mrpdomain-1

IO-Device Parameters (Device Parameters Tab)

Additional Device Parameters tabs can be used to select additional device options, as defined by the device manufacturer. Note: The exact names of the tabs and parameters are derived from manufacturer specific information contained in the associated GSDML file. For example:

Figure 79: Third-Party I/O: Additional Parameter Settings (Product Dependent)

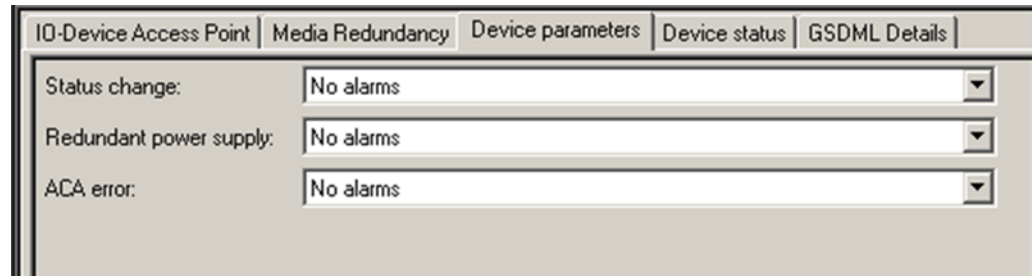

IO-Device Parameters (GSDML Details Tab)

The GSDML Details tab displays the device's GSDML parameters, which cannot be edited.

3.10.2 Configuring Sub-Modules of a Third-Party IO-Device

To configure the sub-modules of a third-party IO-Device, expand it in the Navigator. For example:

Figure 80: Expand Third-Party I/O Device

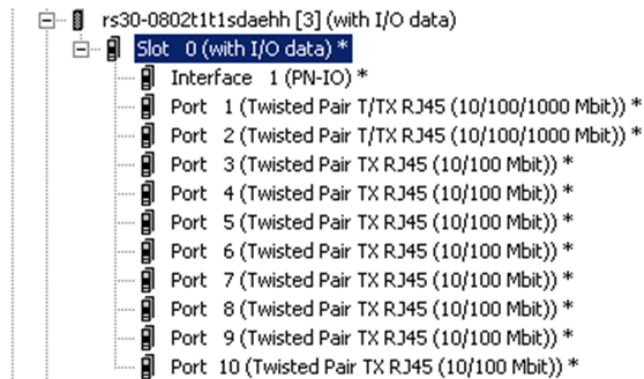

The device in Figure 80 is a switch. The parameters of its ports can be viewed and edited by either double-clicking on a port or selecting a port then right-clicking and selecting Configure from the menu.

For this IO-Device, the port parameters appear for editing (Figure 81).

Figure 81: Editing Port Parameters on Third-Party I/O Device

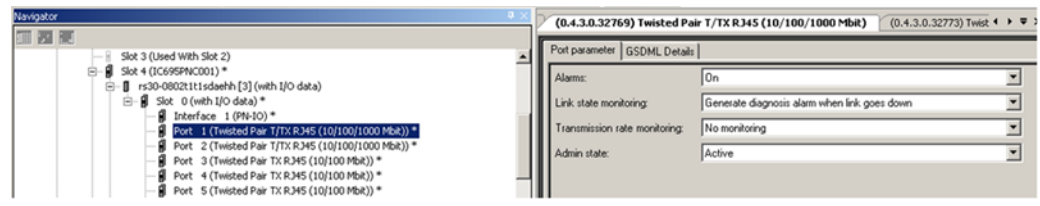

Sub-Module Parameters (GSDML Tab)

The GSDML Details tab displays the device's GSDML parameters, which cannot be edited.

Figure 82: Display of GSDML for Third-Party I/O Device

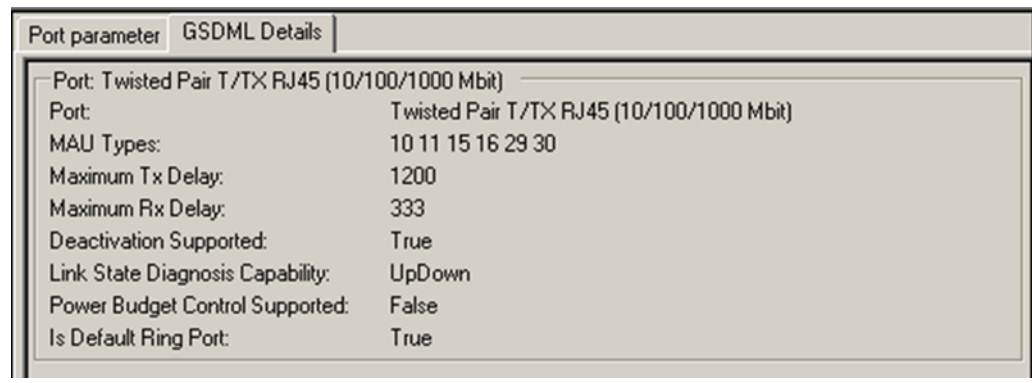

3.11 Viewing / Editing IO-Device Properties

In addition to the parameter configuration described on the previous pages, all IO-Devices (PNS modules and third-party devices) have other configurable properties. These properties are displayed in the Machine Edition Inspector pane when the device is selected in the Navigator.

In the Inspector, properties that are not grayed-out can be used as is or edited as appropriate.

Figure 83: Inspector View of IO-Device Properties

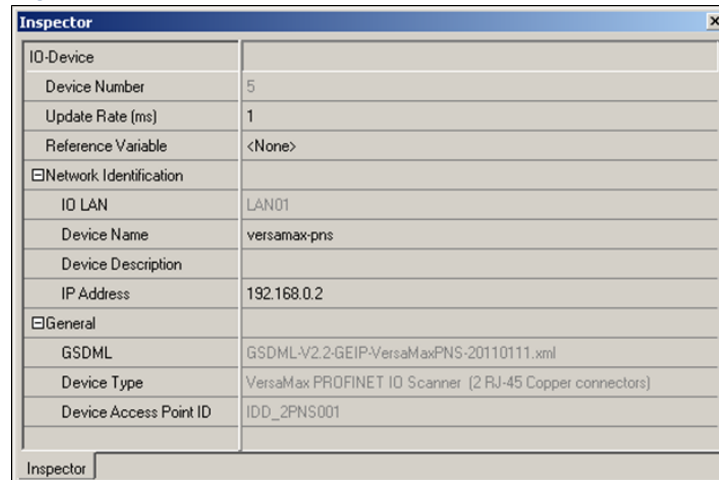

Device Number: a number automatically assigned to the device in the configuration.

Update Rate: The period between PROFINET cyclic data transfers between an IO-Controller and an IO Device. Defaults to 32ms for RX3i and VersaMax PNS modules, and to 128ms for third party devices. To change the update period of the PROFINET production cycle for the IO Device, use the drop-down list to select 1, 2, 4, 8, 16, 32, 64, 128, 256, or 512ms:

Figure 84: Setting of IO-Device Update Rate

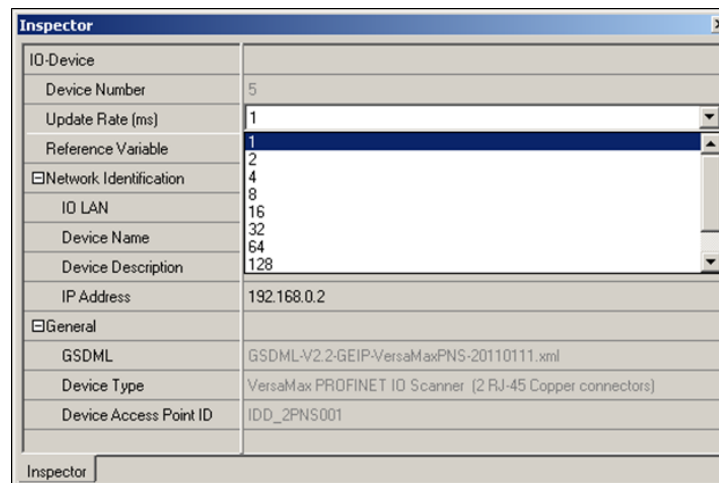

Note: Note that shorter update periods place higher processing loads on the associated PROFINET Controller. Refer to above Section, PROFINET Controller Loading Limits. A PNC001 module can handle heavier loads than an equivalent embedded PROFINET Controller.

Reference Variable: to be used by the PNIO_DEV_COMM logic blocks. The choice defaults to none. To create a reference variable for the device, use the drop-down list to select Create. The variable name appears in the Inspector field:

Figure 85: Assigning Reference Variable to IO-Device

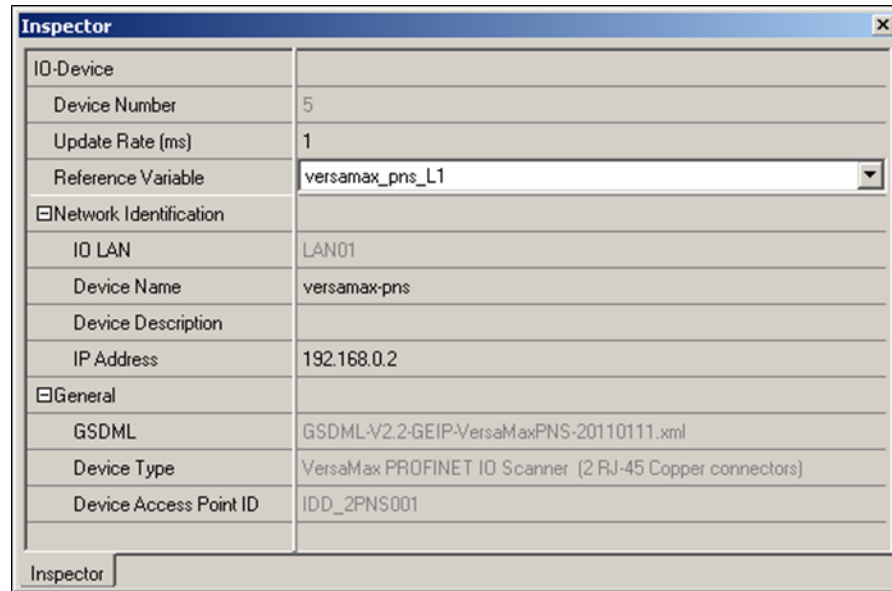

IO LAN: (read-only) identifies the LAN of which the IO-Device is a part.

Device Name: this can be edited within the Inspector, or the default name can be used. Space characters are not permitted.

Device Description: an optional description can be entered for the IO-Device.

IP Address: IP Address for the IO-Device. Default is assigned the lowest value that is currently available within the automatic IP Address range defined for the LAN on which the device resides.

3.12 Assigning IO-Device Names

After the PNS and third-party IO-Devices on the LAN have been configured, the Discovery and Configuration Protocol (DCP) tool in Machine Edition must be used to assign a name to each IO-Device. This step is required before downloading the configuration from the PROFINET Controller. Without this step, the PROFINET Controller would be unable to connect to the devices and deliver their configuration.

The programmer must be connected to the RX3i controller system and the LAN and its devices must be installed.

To open the DCP tool, right-click the hardware configuration slot containing the IC695PNC001 PROFINET Controller and choose Launch Discovery Tool from the menu. Use the Connection dropdown list to select the computer port being used by the programmer to communicate with the RX3i system:

Figure 86: Use of Connection Drop-Down List

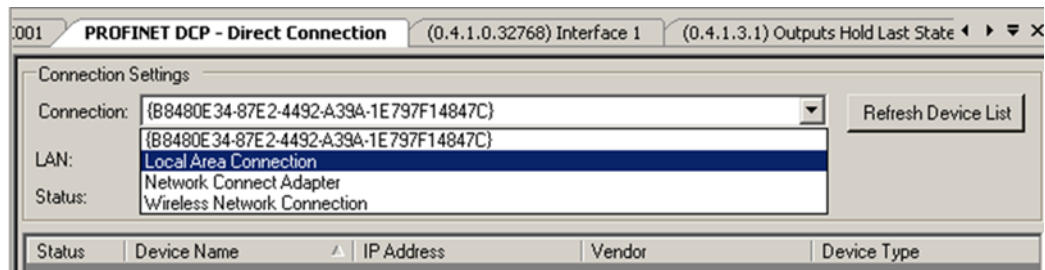

The choices should match the windows network setting in the computer's network control panel.

Figure 87: Equivalent Windows Network Settings

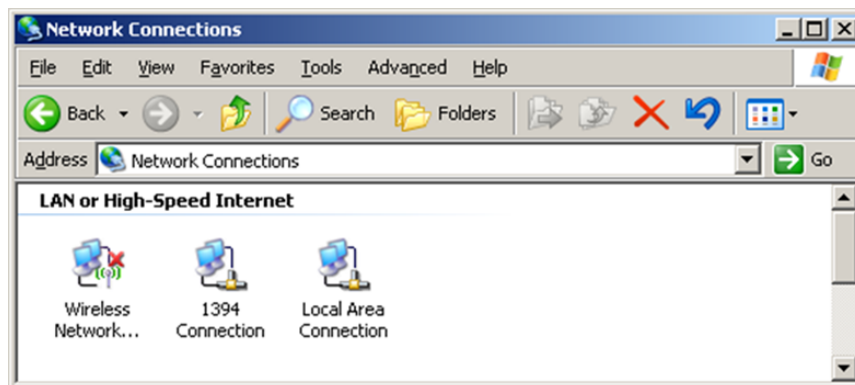

In the DCP tool, use the LAN list to select the configured LAN. The results will be validated against the selected LAN.

Figure 88: Assign LAN

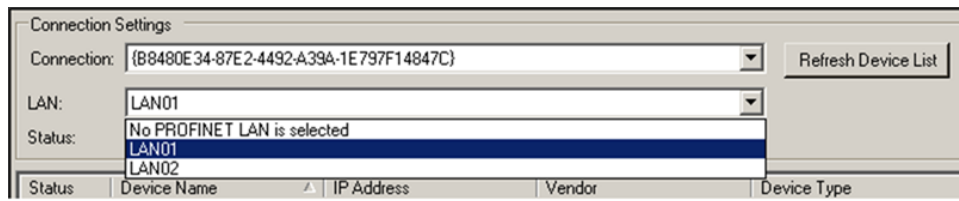

Once a LAN is selected, click on *Refresh Device List* to display a list of actual devices on the LAN. Each device can be in one of three conditions as indicated by the symbol in the *Status* column:



-  indicates that the *Device Name*, *IP Address*, *Subnet* and *Gateway* of the actual device matches the configured device of the same *Device Name* residing on the selected LAN.
-  indicates that the *Device Name* of the actual device matches, but the *IP Address*, *Subnet*, or *Gateway* does not match the configured device of the same *Device Name* residing on the selected LAN.
-  indicates that the *Device Name* of the actual device does not match any configured device residing on the selected LAN. Either there is no such *Device Name* configured in the system, or the device with that *Device Name* resides on a different LAN.

Figure 89: List of Device Names on LAN with Status Indications



If the *Device Name* of the device on the network is not correct, select the target device in the list of networked devices, and click *Edit Device*. This will open a new dialog that can be used to set various parameters, including *Device Name*, directly on the device.

Note: For the PROFINET Controller to successfully deliver configuration to a device, only the *Device Name* is required to match the configuration.

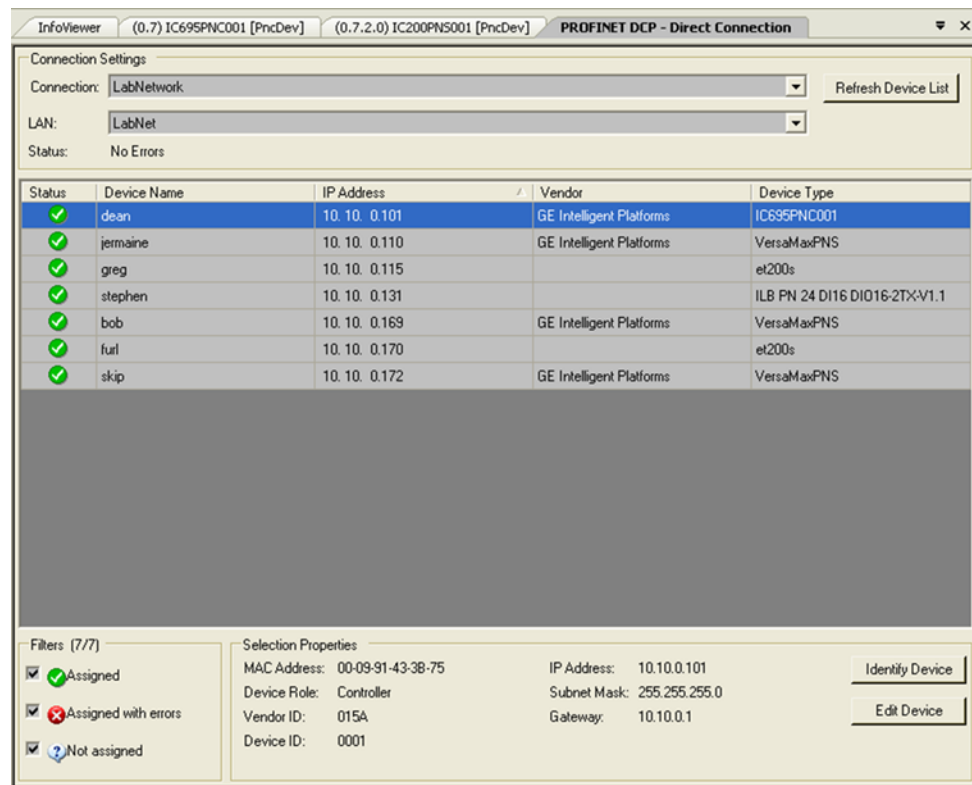
3.13 After the Configuration is Stored to the RX3i CPU

The configuration is stored to the RX3i CPU using Machine Edition. For complete instructions, refer to the PACSystems system documentation. If the configuration is stored to non-volatile memory or is battery-backed, the CPU maintains configuration data over power cycles.

- The RX3i CPU transfers configuration data to the PROFINET Controller.
- After successfully processing and applying its configuration data, the PROFINET Controller turns on its CONFIG LED.
- The PROFINET Controller then transfers the configuration for remote IO-Devices over the PROFINET network.

PROFINET delivers IO-Device configurations when the IO-Controller establishes an Application Relationship (AR) with the IO-Device. If all Application Relationships (AR)s are lost, the IO-Device (such as a VersaMax PNS) does not change the configuration of any of its I/O sub-modules. Each sub-module retains the most recent configuration received since it was last powered up or restarted. If a sub-module has not been configured since power-up or restart, it remains in its hardware default condition. When the AR(s) are re-established and a configuration is sent to the IO-Device, and the configuration of a sub-module has changed, the IO-Device applies the new configuration.

If the PROFINET Controller cannot connect to an IO-Device, the PROFINET Controller logs a Loss of Device fault in its Local Log table and provides the corresponding information to the RX3i CPU for its fault tables. The PROFINET Controller periodically attempts to establish communications and configure the IO-Device. When one of these subsequent connect/configuration attempts is successful, the PROFINET Controller logs an Addition of Device fault for that IO Device in its Local Log table and provides the information to the RX3i CPU for its fault tables.

Note: *It may take up to 5–10 seconds for the PROFINET Controller to establish a connection to an IO Device, including one that previously existed, but was lost.*

- When a VersaMax PNS receives a changed configuration, it temporarily sets all its outputs to their defaults. If the configuration has not changed, a VersaMax PNS does not default outputs. Third-party IO-Devices may operate differently.
- If a PNS is powered up and its modules are at hardware defaults, when it receives a configuration for the first time, any new defaults that are different from hardware defaults are applied until the first output data arrives.

If a PNS is powered up after receiving a configuration and the connection is then lost, configuration defaults are applied when the connection is lost. On a subsequent connection, if the same configuration is sent, outputs remain at the configuration defaults until the first output data arrives. If a different configuration is sent, output defaults transition to the new defaults until the first output data arrives.

Clearing the RX3i CPU Configuration

If the programmer clears the configuration for an RX3i CPU containing a PROFINET Controller, the PROFINET Controller clears its configuration (excluding non-volatile parameters, which are retained), closes all opened PROFINET IO-Device connections, and turns OFF its CONFIG LED.

The RX3i PNS, VersaMax PNS and all third-party IO-Devices react to the clearing of the PROFINET Controller as a loss of connectivity, and take appropriate action, such as defaulting outputs.

Section 4 PROFINET System Operation

This Section describes:

- PROFINET Operation Overview
 - PROFINET Communications
 - Application Relationships
 - Types of PROFINET Communications
 - External Switch VLAN Priority Settings
- Operations of the PROFINET Controller in the RX3i and RSTi-EP
 - Duplicate Device IP Address Detection
 - Duplicate Controller IP Address Detection
 - Resolving Duplicate IP Addresses
- I/O Scan Timing
- RX3i and RSTi-EP CPU Operations for PROFINET
 - Reference ID Variables for the user Application
 - The PNIO_DEV_COMM Function Block
 - Reset Smart Module for the PNC001
 - DO I/O for Remote I/O Modules
 - Scan Set I/O for Remote I/O Modules
 - RX3i and RSTi-EP CPU Defaults Inputs
 - RX3i and RSTi-EP CPU Defaults Outputs

4.1 PROFINET Operation Overview

An RX3i or RSTi-EP CPU uses PROFINET communications for data exchange between it (as the PROFINET Controller) and IO-Devices connected on the same PROFINET network and configured to be under its control. The PROFINET Controller function may be realized by utilizing the embedded PROFINET Controller option in RX3i CPL410/CPE400 LAN2 or CPE330 LAN2 or RSTi-EP CPE205/210/215/220/240 or CPE100/CPE115 LAN2. It may also be realized by installing a rack-mounted IC695PNC001 in the CPU backplane, where permitted.

In all cases, the port used for PROFINET communications is an Ethernet port. While configured for PROFINET, the same network may also be used for basic Ethernet communications. However, use of a separate Ethernet LAN and RX3i Ethernet interface is recommended for most applications.

A PROFINET network can include three types of devices:

PROFINET IO-Controller	In an RX3i or RSTi-EP system, the CPU operates as an IO-Controller. This may be done via the embedded PROFINET feature of certain CPUs (refer to Section 1.2.2) or via a rack-mounted IC695PNC001. It is a controlling device that is associated with one or more PROFINET IO Devices.
PROFINET IO-Device	A PROFINET IO-Device is a distributed I/O Device that is coupled to a PROFINET IO-Controller via PROFINET.
PROFINET IO-Supervisor	An IO-Supervisor can be a programming device, a computer, or an HMI device. The PROFINET IO-Supervisor is typically used for commissioning or diagnostics.

4.1.1 PROFINET Communications

Communications on a PACSystems PROFINET network use the standard PROFINET communications described in this section.

Application Relationships

Before a PACSystems PROFINET IO-Controller can exchange data with a PROFINET IO-Device, an Application Relationship (connection) must be established between the devices. The PACSystems PROFINET IO-Controller automatically sets up the correct number and types of Application Relationship and Communication Relationship channels (see below) based on its PAC Machine Edition configuration. Usually, only one Application Relationship is established per IO Device.

Communication Relationships within an Application Relationship

Within each Application Relationship, the PACSystems PROFINET IO-Controller establishes the following types of Communication Relationships (CRs):

- **Record Data CRs** – always the first to be established within an Application Relationship. Record Data Communication Relationships are used for non-real-time transfers of data records such as startup parameter data, diagnostics data, identification data, and configuration data.
- **IO CRs** – used for the real-time, cyclic transfer of I/O data
- **Alarm CR** – used for real-time, acyclic transfer of alarms and events

Figure 90 represents an Application Relationship between a PACSystems controller with a PNC001 module and an IO-Device. In the example below, the IO Device consists of a VersaMax PNS with VersaMax I/O modules, but the same principles apply for all IO-Controllers and IO-Devices.

Figure 90: Application Relationship

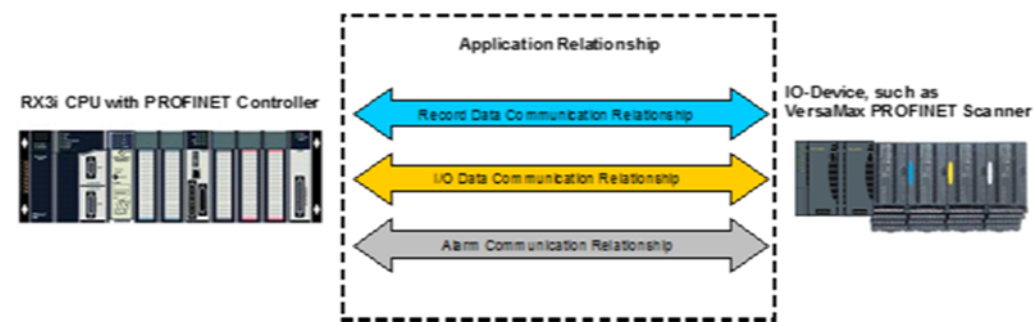

Types of PROFINET Communications

PACSystems PROFINET Controllers use two types of PROFINET communication transfers: real-time and non-real-time. The illustration below shows real-time communications as solid lines and non-real-time communications as dashed lines.

Figure 91: Real-Time and Non-Real-Time Data Communications

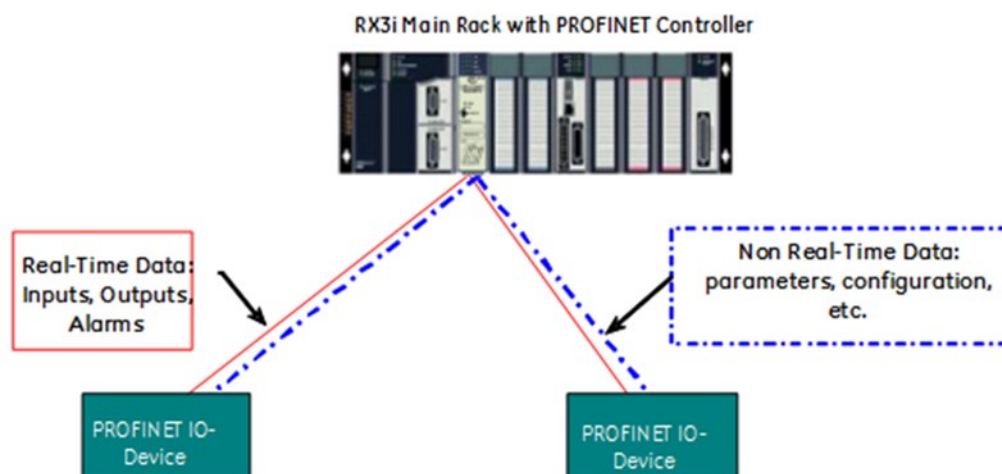

- Real-Time (RT) communication:** PROFINET real-time communication is used for time-sensitive data. A PROFINET IO-Controller and PROFINET IO-Device use two types of real-time communications to exchange data: cyclic communication and acyclic communication:
 - Real-time Cyclic communication is used to periodically transfer the application's input and output data. Cyclic communication occurs each PROFINET IO production cycle.
 - Real-time Acyclic communication is used to transfer non-periodic data such as alarms. Acyclic communication occurs only when needed.
- Non-Real-Time (NRT) communication:** PROFINET non-real-time communication is used for less time-sensitive data such as configuration, parameterization, diagnostics, and identification data.

External Switch VLAN Priority Settings

The PROFINET-IO specification indicates the VLAN priorities for each type of Ethernet traffic that originates from a PROFINET node. VLAN priorities range from 0 to 7, with 7 being the highest.

The PACSystems PROFINET Controller supports just four traffic classes, giving four levels of preference. Incoming traffic without a VLAN priority is assigned to the lowest priority traffic class.

The table below lists the VLAN priorities, and their corresponding priorities in the PROFINET Controller:

VLAN Priority	PROFINET Controller Priority	Ethernet Traffic	Description
7	Highest priority	MRP	Media Redundancy
6	Second-highest priority	RT_CLASS_1	Cyclic PROFINET IO
		High Priority RTA_CLASS_1	High-Priority PROFINET Alarms
5	Third-highest priority	Low Priority RTA_CLASS_1	Low-Priority PROFINET Alarms
4, 3, 2, 1	Lowest priority	(reserved)	(reserved)
0		IP DCP	Device Discovery and Configuration

If a system includes external switches, these switches must be configured to match the VLAN Priority groupings listed above for the PROFINET Controller.

4.2 Operations of the PROFINET Controller in the PACSystems System

The PROFINET IO-Controller in the PACSystems controller system performs the following operations:

- Consumes PROFINET IO-Device configuration from the CPU and transfers it to the IO-Devices over the PROFINET network.
- Consumes input data from each PROFINET IO-Device and makes that data available to the CPU during the CPU's input scan.
- Produces the output data that it receives from the CPU during the CPU's output scan to each PROFINET IO-Device.
- Receives PROFINET alarms and diagnostics from PROFINET IO-Devices and converts them to a PACSystems format.
- Maintains a Local Log Table of its own alarms and the diagnostic information it receives. It also forwards some of the information to the CPU as I/O or Controller Faults.
- Automatically converts between the little-endian data format recognized by the CPU and the big-endian format used for PROFINET communications.
- Checks for duplicate IP Addresses as described below.

4.2.1 Duplicate PROFINET IO-Device IP Address

The PROFINET IO-Controller will detect an IP Address conflict between a device that it is configured to communicate with and another device in two situations:

- First, duplicates are detected when the PROFINET IO-Controller is trying to initially establish communications with the configured PROFINET IO-Device. During the connection sequence, the PROFINET IO-Controller queries the network to see whether any other node has the same IP Address as the configured device.
- Second, duplicates are detected whenever a network device announces its presence⁸ on the network and the IP Address of that device is identical to that of a PROFINET IO-Device that the PROFINET Controller is currently communicating with.

In both cases, the PACSystems PROFINET IO-Controller attempts to establish or maintain the connection and logs a Duplicate IP Address Detected fault for the device. The PROFINET IO-Controller then periodically queries the network for resolution of the IP Address conflict. If the IP Address conflict is resolved, the PROFINET IO-Controller logs a Duplicate IP Address Resolved fault for the device.

4.2.2 Duplicate PROFINET IO-Controller IP Address

The PROFINET IO-Controller detects that a network device has the same IP Address as its own

- during power-up,
- whenever a new hardware configuration is downloaded from the programmer, and
- during operation whenever a device with a conflicting IP Address announces its presence⁹ on the network.

When a duplicate is detected during power-up, following a reset, or following storage of a new hardware configuration, the PROFINET IO-Controller:

- logs a Duplicate IP Address Detected fault for itself,
- does not connect to any configured PROFINET IO Devices,
- periodically queries the network for resolution of the IP Address conflict.

When a duplicate IP Address is detected after the PROFINET IO-Controller has established connection to configured IO-Devices, the PROFINET IO-Controller:

- logs a Duplicate IP Address Detected fault for itself,
- maintains all IO-Device connections
- Note that whenever a second PROFINET Controller with an identical IP Address to the active PROFINET Controller is connected to the network, the second controller will not succeed in entering the network.

When the IP conflict is resolved, the PROFINET IO-Controller:

- logs a Duplicate IP Address Resolved fault for itself,
- attempts to re-connect all configured PROFINET IO-Devices,

⁸ The PROFINET Controller uses the ARP protocol to detect duplicate IP addresses. Devices that issue a gratuitous ARP to announce their presence on the network are detected.

⁹ The PROFINET Controller uses the ARP protocol to detect duplicate IP addresses. Devices that issue a gratuitous ARP to announce their presence on the network are detected.

- logs an Addition of Device fault for each connected PROFINET IO-Device to indicate that device is back online.

Note: *Power cycling a rack that has a PNC001 with the same IP Address as another node on the network will result in two zzz Address Detected faults in the I/O Fault Table. This is normal behavior that occurs because the PROFINET Controller retains IP parameters through a power cycle and attempts to exist on the network before receiving a new configuration from the CPU. The first fault occurs before the PNC001 receives the new configuration and the second fault occurs after the PNC001 receives its new configuration. Both faults result in the PNC001 not attempting to connect to the network.*

4.2.3 Resolving Duplicate IP Addresses

Whenever an IP Address conflict exists, IP-based network communication with the device(s) may be disrupted. The IP Address conflict should be resolved by disconnecting one of the offending devices from the network or assigning each a unique address. The Duplicate IP Address Detected fault lists the MAC address of the offending devices in bytes 8 – 13 and 14 – 19 of the Fault Extra Data. The Discovery and Configuration Protocol (DCP) tool in PAC Machine Edition may be useful to identify PROFINET devices on the network with conflicting IP Addresses.

4.3 I/O Scanning

In the PACSystems PROFINET network, multiple I/O cycles run asynchronously and independently. Figure 92 illustrates typical cycles in a system with a PACSystems CPU with a PROFINET Controller, and PNS modules used as the head-end in IO Devices. Cycles may be different for third-party devices.

Figure 92: Diagram of Multiple Asynchronous I/O Scans

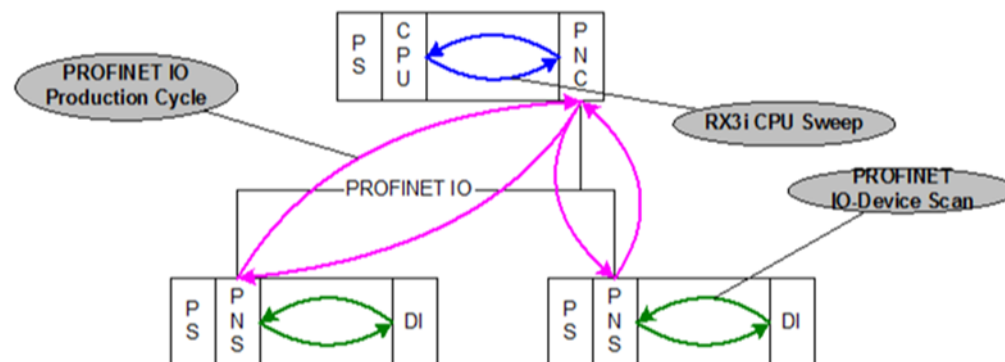

- PROFINET IO-Device Scan:** in Figure 92, each VersaMax PNS scans all the modules in its node as quickly as possible. The PNS stores the input data gathered from each of the input modules in that node into its internal memory. On each output scan, the PNS writes the output data from its internal memory to the output modules in its node.

3rd party devices: The conveyance of I/O data between an I/O module and the PROFINET IO network is device dependent. Third party manufacturer documentation should be referred to for specifics for a device.
- PROFINET IO Production Cycle:** each PROFINET Controller in a CPU node and each IO Device publishes data from its internal memory onto the network at each scheduled PROFINET production cycle (note: production cycles between IO Controllers and IO Devices are not synchronized, each publishes at its configured update rate independently). The PROFINET Controller publishes output data received from the CPU to each IO Device, and the IO Device publishes input data from its memory to the PROFINET Controller.
- PACSystems CPU Sweep:** the PACSystems CPU Sweep includes both an input scan and an output scan. The CPU input scan retrieves the current input data being stored within the PROFINET Controller. This input data is then available for use by the application logic. After the logic solution, the CPU output scan writes the outputs to the PROFINET Controller.

4.4 Data Coherency

In a PACSystems PROFINET network, it is important to note that I/O data coherency is at the PROFINET submodule level. The PROFINET Controller coherently transfers I/O data to and from the CPU on a PROFINET submodule basis. This means that output data from a single CPU output scan for multiple PROFINET submodules may not be transferred during the same PROFINET IO production cycle. Conversely, input data consumed from a single PROFINET IO cycle by the PROFINET Controller may not be consumed during a single CPU input scan.

4.5 Performance Factors

There are many factors that affect the timing of I/O as it flows through the system. Primary factors include:

- CPU Sweep Time
- Configured PROFINET IO Update Rate(s)
- Number of PROFINET IO Devices
- Number of IO modules
- Network latency and loading (for example, switching hardware, additional non PROFINET network traffic)
- I/O Module Filter Times

When designing a PROFINET IO system, consider and weigh these factors appropriately to achieve an optimal IO system for the application.

4.6 PROFINET IO Update Rate Configuration

Selecting PROFINET IO update rates is one of the primary means for adjusting performance of the system. Consider the following when choosing an appropriate value.

- In general, for most applications, there is little benefit to configuring PROFINET IO update rates faster than half the CPU Sweep time. Scheduling PROFINET IO update rates faster than required by the application creates unnecessary loading on the network, PROFINET Controller, and PROFINET IO devices.
- Keep in mind that transferring IO over the PROFINET IO network could take up to one complete PROFINET update cycle time for the transfer to occur. Since PROFINET IO production is asynchronous to the source of the produced data, in the worst case the new production data could miss a PROFINET IO production cycle, and thus must await the next cycle. Note, this means for an I/O loopback situation where an application asserts an output and expects to see the output echoed on another input, and if there are two PROFINET transfers involved, then it may take two PROFINET IO production cycles (one for each data transfer).
- It is possible that the PACSystems CPU, through application logic actions, can update output data for a Remote IO Module faster than the usual I/O update rate of that remote I/O module. The application logic must be careful not to update output data faster than the scanning of the Remote IO Module (which is a function of both the PROFINET IO Update Rate and IO-Device Scan). Otherwise, output data from the CPU may not transfer to the Remote IO Module before being overwritten by new output data from the application logic.

4.8 PACSystems CPU Operations for PROFINET

This section describes several PACSystems CPU functions as related to their operation when used with a PROFINET network.

In addition, PACSystems CPUs with version 7.0 or later firmware and PAC Machine Edition version 7.0 or later provide special tools for use in systems with PROFINET networks based on the PROFINET Controller:

- Reference ID Variables (RIVs)
- PNIO_DEV_COMM function block

4.8.1 Reference ID Variables for the PACSystems Application

RIVs are available to the PACSystems application logic to provide a simple symbolic reference to an entity. The following RIV types are defined for use with PROFINET Controllers and IO Devices.

RIVs are assigned in PAC Machine Edition by editing the Properties for a PROFINET Controller or IO Device in the hardware configuration.

Reference ID Variable Data Types

Data Type	Associated With
PNIO_CONTROLLER_REF	PACSystems PROFINET Controller
PNIO_DEVICE_REF	PROFINET IO-Device

PNIO_CONTROLLER_REF Variable

Each PACSystems PROFINET Controller can have a PNIO_CONTROLLER_REF variable assigned to it.

When assigned, it is linked to the PROFINET Controller, and its value cannot be changed. If a linked PNIO_CONTROLLER_REF variable is present, the application logic and hardware configuration are coupled. The name of the PNIO_CONTROLLER_REF linked variable corresponds to the controller's Device Name used in the hardware configuration to identify the module on the PROFINET network. Whenever the PNIO_CONTROLLER_REF variable is renamed, PAC Machine Edition will make sure all uses of that variable in logic convert to the new variable name.

Unlinked PNIO_CONTROLLER_REF variables can be passed to the IN and Q parameters of the MOVE_DATA function block. Linked PNIO_CONTROLLER_REF variables can only be passed to the IN parameter of the MOVE_DATA function block.

PNIO_DEVICE_REF Variable

An RIV of type PNIO_DEVICE_REF uniquely identifies a PROFINET IO-Device. It is an unsigned integer in the range of 1 – 255.

Each PROFINET IO-Device in a PACSystems hardware configuration can have a PNIO_DEVICE_REF variable assigned to it. When assigned, it is linked to a PROFINET IO-Device. When a linked PNIO_DEVICE_REF is present, the logic and hardware configuration are coupled. The name of the PNIO_DEVICE_REF linked variable corresponds to a combination of the LAN ID and the Device Name used to identify the IO-Device on that LAN. Whenever the PNIO_DEVICE_REF variable is renamed, PAC Machine Edition will make sure all uses of that variable in logic convert to the new variable name.

Unlinked PNIO_DEVICE_REF variables can be passed to the IN and Q parameters of the MOVE_DATA function block. Linked PNIO_DEVICE_REF variables can only be passed to the IN parameter of the MOVE_DATA function block.

4.8.2 PNIO_DEV_COMM Function Block

The PNIO_DEV_COMM function block monitors communications between a specified PROFINET Controller and a specified IO-Device.

Figure 93: PNIO_DEV_COMM Function Block



PNIO_DEV_COMM can be used by the application logic to take a corrective action or turn on an indicator if a specific device fails. It might also be used by a custom HMI to show which PROFINET IO-Device connections are currently established.

It is recommended that the All Devices Connected status bit be checked first to determine whether all devices belonging to the PROFINET Controller are functioning. If this bit is 0, indicating that one or more devices is not OK, the PNIO_DEV_COMM function block can then be used to determine which specific devices are not communicating. For details on this status bit, refer to Status Reporting in Section 5 Diagnostics.

Parameters and Outputs of PNIO_DEV_COMM

PNIO_DEV_COMM returns a Boolean indication of whether a given PROFINET Controller is currently communicating with a specified IO Device. The PROFINET Controller is identified by the I/O Controller input parameter, which is a PNIO_CONTROLLER_REF data type. The IO-Device is identified by the I/O Device input parameter, which is a PNIO_DEVICE_REF data type.

PNIO_DEV_COMM has two Boolean outputs (in addition to ENO) labeled OK and Primary.

OK is set ON/true if the PROFINET Controller is successfully communicating with the IO-Device; otherwise, it is OFF/false.

Primary is set ON/true if the IO-Device is currently being actively controlled by the PROFINET Controller. In a Hot Standby CPU redundancy application, only one PROFINET Controller is actively controlling an IO-Device at any given time. For details, refer to the *PACSystems Hot Standby CPU Redundancy User's Manual*, GFK 2308.

The application logic must identify the PROFINET Controller and the IO Device in a symbolic manner, passing appropriate Reference ID Variables (see Figure 94) to the corresponding input parameters.

Example

In the sample logic (Figure 93), the RIV `iolan_controller01_L3` is assigned to a PROFINET Controller and the RIV `iolan_controller01_L3` is assigned to an IO-Device.

If the `iolan_controller01_L3` PROFINET Controller is communicating with the `versamax_pns01_L3` IO Device, the Bool variable `L3_PNC01_PNS01_Status` is set on. In a simplex (non-redundant) system the value of the Primary output is the same as that of the OK output. In a Hot Standby CPU Redundancy system, the Primary output sets the `L3_PNC01_Primary` variable on when the `iolan_controller01_L3` Controller is actively controlling the `versamax_pns01_L3` IO Device.

Figure 94: PNIO_DEV_COMM Example

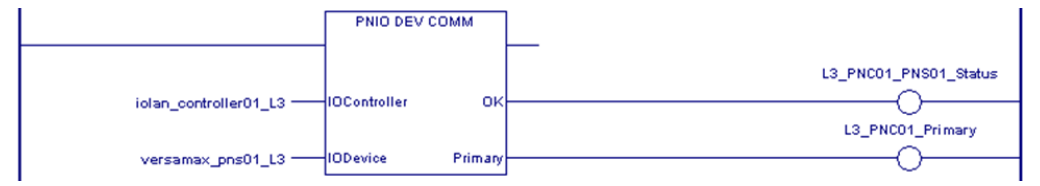

4.8.3 Reset Smart Module for the PROFINET Controller

Service Request 24, Reset Smart *Module*¹⁰, can be used to reset a PNC001 module in the PACSystems RX3i CPU rack. The result is the same as extracting the PNC001 module from the rack and then re-inserting it.

When the RX3i CPU encounters the Reset Smart Module service request in the application logic, it issues a reset command to the specified module (in this case, a PNC001). The PNC001 terminates all connections to PROFINET IO-Devices. When the PNC001 powers up and re-establishes communications with the CPU, the CPU sends the appropriate configuration to the PNC001, and the PNC001 re-establishes connections with all its configured PROFINET IO Devices.

Note: *The Reset Smart Module request cannot be used to reset smart modules located in remote nodes.*

4.8.4 DO I/O for Remote IO Modules

In addition to the normal I/O updates that occur during the PACSystems CPU's scan, the application program in the CPU can use the DO I/O function to access the I/O data associated with Remote IO Modules on the PROFINET network during the logic portion of the CPU sweep. The DO I/O function can obtain or update the most recent I/O data that is being consumed from or published to the Remote IO Module by the PROFINET IO Controller. The DO I/O function can also be used to obtain data associated with the PROFINET Controller itself.

It is important to remember that the I/O data being read or written by the DO I/O function is data currently being stored by the PROFINET Controller within its memory. Executing a DO I/O function from the CPU does not cause additional data to be produced or consumed on the PROFINET NETWORK. Updates of the actual Remote IO Module I/O data occur during the configured PROFINET cyclic scanning schedule. The DO I/O function provides the benefit of immediately updating I/O data at the PROFINET Controller, as opposed to waiting for the next normal I/O scan. The DO I/O function can also be used to obtain the latest input status from the PROFINET Controller (see Section 5 Diagnostics).

4.8.5 Scan Set I/O for Remote I/O Modules

The Scan Set I/O function of the PACSystems CPU requests the scanning of remote modules that are members of a configured scan set. The Scan Set I/O function operates like a DO I/O function, with the added ability to identify and group the modules to be scanned. Modules are grouped according to their configured scan sets. As with the DO I/O function, the Scan Set I/O function updates/consumes data stored in the local PROFINET Controller; it does not directly update IO-Devices in remote nodes.

¹⁰ This Service Request is not supported by embedded PROFINET Controllers.

4.8.7 PACSystems CPU Defaults - Inputs

The PACSystems CPU defaults input data from remote I/O modules under the following conditions:

- the remote module or PROFINET Controller has not yet come online following a download of hardware configuration
- the remote module or PROFINET Controller has not yet come online following a power cycle
- the remote module signals its input data is no longer valid (e.g., due to local module fault)
- the remote module is extracted from the backplane
- the remote module loses power or otherwise fails
- the PROFINET Controller loses power or otherwise fails
- the PROFINET network connection (Application Relationship) associated with the input data is lost.

The PACSystems CPU defaults the input values of an input module based on the input default state configured for the I/O Device. Inputs may be configured to either Hold Last State or Force Off (zero).

If a PROFINET Controller loses connections to an I/O device, the following actions occur:

1. The CPU defaults the input values of all input modules assigned to it within the IO Device.
2. The PROFINET Controller logs a Loss of Device fault in its Local Log and in the CPU's I/O Fault Table.
3. The I/O point fault contacts for the I/O references and variables associated with the IO-Device are set to the faulted state (if point faults are enabled on the CPU).

4.8.8 PACSystems CPU Defaults - Outputs

Outputs default when the CPU is no longer providing the data (e.g., when CPU has I/O disabled). For I/O modules which control their own output defaults based on their configuration, the output behavior is determined by that configuration setting. For I/O modules which do not have such a configuration setting, the output default behavior is fixed (typically 0). Refer to the specification for each I/O module type to determine behavior.

Section 5 Diagnostics

This Section describes:

- Power-up and Reset
 - Module Restart
 - Problems during Power-up and Reset
 - Transitioning to Firmware Update Mode
- Special LED Blink Patterns
 - Special LED Patterns - Module Identification
 - Special LED Patterns – Microprocessor Overtemperature
- Fatal Error Reporting
- Status Reporting
- Fault Contacts and Fault Locating References
- PROFINET I/O Alarms
- The PROFINET Controller's Local Log Table
 - Local Log Table-Only Faults
 - Viewing and Clearing the Local Log Table
- PROFINET Controller Faults in the PACSystems Fault Tables
 - Clearing the PACSystems Fault Tables
 - Faults Reported to the Controller Fault Table
 - Faults Reported to the I/O Fault Table

5.1 Power-up and Reset (PNC001 Module)

During power-up and reset, the PNC001 module runs diagnostics and initializes its hardware components. When the necessary hardware components have been initialized and tested, the PNC001 transitions to either normal operation or firmware update mode.

As the PNC001 module transitions to normal operation, it adds a startup entry that provides a reason for the restart in its Local Log table. This entry is normal.

5.1.1 Module Restart

The PNC001 restarts if it receives a Reset signal from the PACSystems RX3i CPU, if the Restart Pushbutton is pressed, if the restart or default command is issued from the Command Line Interface (refer to the *PROFINET Controller Command Line Interface Manual*, GFK-2572), or if the hardware watchdog timer expires. More details on each type of restart are given below.

When the PNC001 is restarted, it retains any entries in its Local Log table and its non-volatile configuration parameters. Any debug data in non-volatile storage can be viewed from the Command Line Interface using the log or show log commands.

Restart Triggered by Reset Signal from the PACSystems CPU

The PACSystems RX3i CPU resets/restarts a resident PNC001 module if:

- The application logic executes SVC_REQ #24, specifying the rack and slot of a PNC001 module.
- The RX3i CPU loses communications with the PNC001.
- The PNC001 requests the RX3i CPU to reset / restart it (for example, as a result of a restart or default Command Line Interface command execution).

Note: *This feature applies to PNC001 modules but does not apply to CPUs with embedded PROFINET Controllers.*

Restart Triggered by Restart Pushbutton

Pressing and releasing the Restart pushbutton on the PNC001 module resets the hardware, turns OFF all LEDs briefly and initiates the module's power-up sequence. The Restart pushbutton may also be used to restart the module if the OK LED is blinking an error code upon hardware or runtime failure, or if the module locks up.

Restart Triggered by Restart and Default Command

Issuing a restart or default command from the Command Line Interface causes the PNC001 to restart. Modify-level privileges are required to issue these commands.

Restart Triggered by Hardware Watchdog Timer

The PNC001 maintains a hardware watchdog timer that will restart the module if it is unable to carry out its normal processing. The PACSystems RX3i CPU is not able to access the PNC001 module's shared memory while the PNC001 is restarting.

After the restart, the module's Local Log table is restored from NVRAM. The PNC001 logs a Watchdog Timer Expired fault in the RX3i CPU's IO Fault Table, and a Restart Event in its Local Log table.

5.1.2 Problems During Power-up and Reset

Certain conditions can prevent the module from powering up and becoming operational or entering firmware update mode:

Problem	Indication	Action
Hardware failure	All LEDs off. Module unresponsive.	Return the module Emerson.
Invalid bootstrap image		
Invalid boot image	No LEDs turn on and the module is unresponsive, or The <i>STATUS</i> LED is solid green and is the only LED that is on.	
Power-up diagnostics/hardware initializations fail that are considered fatal	LED Fatal Error blink code, as described in this chapter.	Note the blink code and contact Customer Service.
Non-Fatal diagnostic/hardware initialization faults	The module continues normal power-up, but an entry is added to the Local Log table and the RX3i CPU's Fault Table (if backplane communications have been established).	Note the fault and contact Customer Service.
The module does not contain hardware identity information	LED Fatal Error blink pattern, as described in this chapter.	Note the blink code and contact Customer Service.

5.1.3 Transitioning to Firmware Update Mode

The module transitions to firmware update mode for any of the following reasons:

1. WinLoader has commanded the module to enter firmware update mode. This is normal when a firmware update has been initiated from WinLoader.
2. The PNC001 does not have a valid firmware image at power-up. The PNC001 performs checks to determine the firmware image is valid and has not been corrupted before it begins execution. If the validation fails, firmware update mode is activated until a valid image has been stored.

For more information about firmware update mode and using WinLoader, please see Section 2 Installation.

5.2 Special LED Blink Patterns

In addition to the LED blink patterns that indicate a fatal error, the PNC001's LEDs can indicate module location/identification and microprocessor overtemperature conditions, as described below.

Special LED Blink Patterns are not supported by RSTi-EP CPE205/210/215/220/240 and CPE100/CPE115 embedded PROFINET Controllers.

5.2.1 Special LED Pattern - Module Identification

The LEDs on a PNC001 module can be commanded to repeatedly turn ON and OFF in a special sequence, to help locate or identify the module.

For the PNC001-Ax:

- First the LEDs are turned on in the following order: OK, LAN, STATUS, CONFIG, PORT 4, PORT 3, PORT 2, PORT 1. There is a short delay between turning on each LED.
- The LEDs are then turned off in the same order. There is a short time delay between turning off each LED.

For the PNC001-Bxxx:

- First the green port speed LEDs are turned on in a circular order. There is a short delay between turning on each LED.
- The LEDs are then turned off in the same order. There is a short time delay between turning off each LED.

For the -Ax version, the command, `blinkId <begin/end>` is issued via the Command Line Interface. Issuing the `blinkId begin` command starts the identification blink sequencing while the `blinkId end` stops the identification blink sequencing. When issued from the Command Line Interface, the last command session that commands the IDENTIFICATION blink pattern determines its state (either blinking or stopped). Note that the `blinkId` command requires Modify-level access to the Command Line Interface.

For the -Bxxx version, the Module Identification LED Pattern is initiated by the PROFINET DCP Identify Device command. Module Identification can be initiated using the PAC Machine Edition Discovery Tool by refreshing the device list, double clicking on the RX3i PNC row, and clicking the Identify Device button on the device properties pop-up window.

5.2.2 Special LED Pattern - Microprocessor Overtemperature

If the maximum threshold temperature for the microprocessor is exceeded, the PNC001 goes into power-saving mode. While the PNC001 is in an overtemperature condition:

- the LEDs on the PNC001-Ax module behave as follows:
- PORT 1, PORT 2, and STATUS LEDs flash red for 0.5 seconds (all other LEDs off), then PORT 3 and PORT 4 LEDs flash red for 0.5 seconds (all other LEDs off). This pattern repeats.
- the LEDs on the PNC001-Bxxx module behave as follows:
- the PORT NUMBER LEDs flash red for 3 seconds and then all LEDs turn off. This pattern does not repeat.

The PNC001 stays in power-saving mode until the temperature drops to a safer level. Once a safe temperature is reached, the PNC001 module restarts. When the PNC001 is restarted, it retains any entries in its Local Log table and its non-volatile configuration parameters. For the -Ax version, any debug data in non-volatile storage can be viewed from the Command Line Interface using the log or show log commands.

Note: *Under certain ambient operating temperatures, the PNC001 may momentarily display the overtemperature pattern during power up, while it is calibrating its thermal protection functions. This indication may be ignored, and no overtemperature entry is added to the Local Log table, the Controller Fault Table, or I/O Fault Table.*

5.2.3 Firmware Update

While the PNC001 is in firmware update mode, the OK, LAN, and STATUS LEDs blink green for 0.5 seconds and then off for 0.5 seconds in unison. During firmware update operation, the ports are disabled, so all the PORT NUMBER LEDs are off. The CONFIG and LAN LEDs are also off. The USB LED (-Ax only) operates normally, displaying the condition of the USB port.

5.2.4 Internal Update

Some changes from a firmware update are applied to the system on the next power up. During this internal update process, the STATUS and LAN LEDs blink green for 0.5 seconds and then off for 0.5 seconds in unison. At the completion of the internal update process, the PNC001 restarts and should power up normally.

5.3 Status Reporting

The PNC001 module and any embedded PROFINET Controller both provide 32 bits of status information to a configured location in the PACSystems CPU's reference memory.

The status data consists of the Module OK bit, which indicates the health of the module itself, a status bit for each external port, and a bit that indicates the connection status of the configured devices.

All Status bits are active high. The status location may be configured in %I, %Q, %AI, %AQ, %R, %G, %T, %M or %W or I/O Variable reference memory in the PACSystems CPU.

Status Bit Definitions

Bit	Name	Description
1	Module OK	Indicates the health of the PROFINET Controller. 1 indicates the PROFINET Controller is functioning properly. 0 indicates the PROFINET Controller is not functioning properly.
2	Port1 Link Up	1 indicates the port is connected to another device and is operating correctly. 0 indicates the port is not connected to another device, the port has an error preventing communications, or the SFP cage is empty or has an incompatible SFP device.
3	Port2 Link Up	
4	Port3 Link Up ¹¹	
5	Port4 Link Up ¹¹	
6	Reserved	Always 0.

¹¹ Applies to PNC001 module only. Bit is set to zero on embedded PROFINET Controllers.

Bit	Name	Description
7	Port3 SFP OK ¹¹	Indicates the health of the SFP plugged into Port 3. 1 indicates that the SFP matches configuration and is operational. 0 indicates that either the SFP does not match configuration or is not operational.
8	Port4 SFP OK ¹¹	Indicates the health of the SFP plugged into Port 4. 1 indicates that the SFP matches configuration and is operational. 0 indicates that either the SFP does not match configuration or is not operational.
9	All Devices Connected ¹²	1 indicates all configured devices are connected and communicating over PROFINET. 0 indicates no devices are configured or one or more configured devices have not established a PROFINET connection. CPE205/210/215/220/240 turn their REM IO LED on GREEN when ALL devices are connected. The REM IO LED turns on AMBER if only some devices are connected. The REM IO LED will be OFF if no devices are connected.
10	Reserved	Always 0.
11	MRP Enabled	0 indicates that MRP is not enabled. 1 indicates that MRP is enabled.
12	MRP Role	If MRP is enabled: 0 indicates that the PROFINET Controller is currently an MRP client (MRC). 1 indicates that the PROFINET Controller is currently the MRP Manager (MRM). If MRP is not enabled, this bit will be set to 0.
13	MRP Ring Status	If MRP is enabled and the PROFINET Controller is currently the MRM: 0 indicates that the ring is open (ring broken). 1 indicates that the ring is closed (ring complete). If MRP is not enabled, or if the PROFINET Controller is an MRC, this bit will be set to 0.
14-32	Reserved	Set to 0

5.4 I/O Fault Contacts

The PROFINET Controller sets I/O point fault contacts to the faulted state whenever an IO-Device is not available or there is a problem with the I/O module.

If the control application needs to know whether a set of inputs is available or not, it must refer to the input point faults. For example, immediately following a power cycle or recent download of

¹² Individual device statuses (as reported by the PNIO_DEV_COMM function block) are updated prior to the All Devices Connected bit. Therefore, it is possible (depending on PNC loading) to see via the PNIO_DEV_COMM function block that every individual device is connected while the All Devices Connected bit is not yet set. To avoid this inconsistency, it is recommended that the All Devices Connected bit be checked first, before checking individual device connection status using the PNIO_DEV_COMM function block. For details, refer to the section entitled PNIO_DEV_COMM Function Block.

hardware configuration, the PACSystems CPU can go to Run mode before the PROFINET Controller and its configured IO Devices are ready to transfer inputs. During this time, the inputs for each IO-Device are defaulted and the corresponding input point faults remain in the faulted state until both the PROFINET Controller and the IO-Device are ready to transfer inputs. By inspecting the input point faults, the application can determine when the inputs are ready to be consumed.

Hot Standby CPU Redundancy systems do not support output point faults. For details, refer to the *PACSystems Hot Standby CPU Redundancy User's Manual*, GFK-2308.

In order to be used, I/O point faults must be enabled in the CPU configuration. For details, refer to the *PACSystems RX7i, RX3i and RSTi-EP CPU Reference Manual*, GFK-2222 and to the *PACSystems RX7i, RX3i and RSTi-EP CPU Programmer's Reference Manual*, GFK-2950.

5.5 Fault Locating References

The Fault-Locating References for a PNC001 module can be used for rack-level and slot-level faults. These names can be programmed on the FAULT and NOFLT contacts:

- #RACK_000r
- #SLOT_0rss

where r represents the rack number and ss represents the slot number

These names cannot be used to check for faults on a PROFINET IO-Device, remote module, or remote sub-module.

The reserved fault names are always available. These fault names do not correspond to %SA, %SB, %SC, or to any other reference type. They are mapped to a memory area that is not user accessible.

Fault Locating References are not supported by embedded PROFINET Controllers.

5.6 Fatal Error Reporting

If the PNC001 module encounters a Fatal error, it tries to save diagnostic information to non-volatile storage. The RX3i CPU then resets the PNC001 module.

Diagnostic information can be viewed from the Command Line Interface using the show debug fatalInfo command.

5.7 PROFINET IO Alarms

PROFINET I/O uses Alarms to transfer indications of changes or problems in the remote IO Device. For example, Diagnosis Alarms are used to indicate a problem with a channel such as a short circuit, a blown fuse, or overtemperature condition. The PROFINET Controller translates PROFINET alarms into CPU faults for the PACSystems CPU. Figure 95 shows what happens when a problem is detected on one of the channels of a module within a remote IO Device, in this case, a VersaMax PROFINET Scanner.

1. The PROFINET Controller establishes Application Relationship (AR) and then Alarm Communication Relationship (CR) with the PROFINET IO-Device
2. Module detects a problem (such as a short circuit) and reports it to the IO-Device (PROFINET Scanner)
3. IO-Device sends Alarm to PROFINET Controller via Alarm CR.
4. PROFINET Controller logs fault in its Local Log and passes it to the CPU Fault Table.
5. PROFINET Controller sends Alarm ACK to IO-Device via Alarm CR.

Figure 95: Alarm Processing Phases

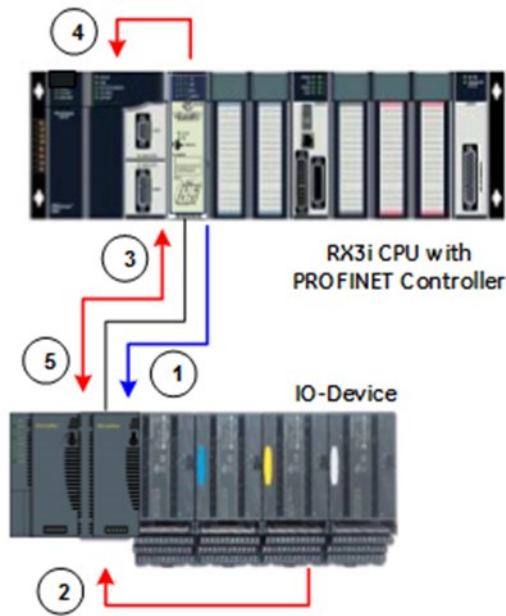

PROFINET Alarm Action

If a PROFINET I/O Alarm occurs, the action is Diagnostic (the action type is not configurable). When a fault in this group is processed, the CPU sets the following status bits: #ANY_FLT, #IO_FLT, #IO_PRES, and #PNIO_ALARM (%SA30).

The #PNIO_ALARM status bit is cleared whenever the I/O Fault Table is cleared.

5.8 Local Log Table of the PROFINET Controller

Since the embedded PROFINET and PNC001-Bxxx do not support the Command Line Interface (CLI), while the older PNC001-Ax module does support CLI, the interactions become a little confusing. When reading this section, keep in mind that CLI is supported by PNC001-Ax only. The Local Log Table is still present and behaves the same in all respects, except for CLI interactions.

The Local Log table in the PROFINET Controller contains entries indicating events and errors. There can be three types of entries in the Local Log table:

- Local faults. These are viewable only using the Command Line Interface.
- Controller faults. These are passed to the PACSystems CPU Controller Fault Table, provided the PROFINET Controller was in communication with the CPU at the time the entry was added to the log.
- I/O faults. These are passed to the PACSystems CPU I/O Fault Table, provided the PROFINET Controller was in communication with the CPU at the time the entry was added to the log.

The PROFINET Controller maintains these entries in its Local Log table. Entries in the Local Log are preserved across power-cycles. In the PNC001-Ax module, they may also be cleared using the CLI clear log command.

Clearing the CPU Fault Tables or restarting the PROFINET Controller does NOT clear the Local Log table.

If the Local Log table overflows, new entries overwrite the oldest entries, which are then lost. If that happens, CLI indicates the number of entries that have been discarded. The count of discarded entries is reset to zero whenever the Local Log table is cleared (applies to PNC001 module only).

The STATUS LED on the PNC001-Ax module provides an indication that a new fault has been added to the module's Local Log since either the last time the module was restarted, or since the last time the log was cleared. The STATUS LED is ON at power-up, after the Local Log has been cleared, or after executing the clear statLED command from CLI. When a subsequent fault occurs, the STATUS LED turns OFF to indicate that a new fault has been logged.

5.8.1 Faults Unique to Local Log Table

The following faults are registered in the Local Log table of the PROFINET Controller and in no other table. When viewed using the CLI log details command, they have an Entry Type of Local Fault.

The Local Log Table also contains faults that are passed to the PACSystems CPU. Those faults, which are listed in the

PROFINET Controller Faults in the PACSystems Fault Tables section of this chapter, are not repeated here.

Group/ Error Code	Description	Cause	Recommended Correction
2-1	PNC001 restarted.	<p>The PNC001 has experienced a restart. Possible causes include:</p> <ul style="list-style-type: none"> - PNC001 power-cycled - PNC001 reset button pushed - PNC001 command shell command to reset board issued - PNC001 firmware updated - PNC001 exceeded safe operating temperature - PNC001 hardware watchdog timer expired - PNC001 internal fatal error encountered <p>The reason for the reset is indicated by the description shown when displaying the fault.</p>	If the PNC001 restart is due to a hardware watchdog timer expiration, or internal fatal error, note the Fault Extra Data and contact customer service.
2-2	Time synchronization with PACSystems RX3i controller failed.	The PNC001 was unable to synchronize its current time with the PACSystems RX3i controller.	Contact customer service.
2-4	Invalid Media Redundancy Configuration	PROFINET Controller encountered an error related to applying Media Redundancy configuration parameters.	Contact customer service.
4-1	Socket close failed	PROFINET Controller was unable to close an opened OS socket.	Contact customer service.
5-1	CLI null environment pointer	PNC001 encountered a null pointer while processing a command via the CLI.	Contact customer service.
5-3	CLI Ethernet command failure	PNC001 encountered an error while processing an Ethernet related command.	Contact customer service.
5-4	CLI PNC specific command failure	PNC001 encountered an error while processing a PNC001-specific CLI command.	Contact customer service.
5-5	CLI initialization failure	The Command Line Interface functionality on the PNC001 failed to initialize correctly.	Contact customer service.
6-1	Write to nonvolatile memory failure	The PROFINET Controller failed to write data to non-volatile memory, which could result from configuration store/clear operations from the programmer, or Command Line Interface commands.	Contact customer service.
8-1	Return of Submodule PROFINET Alarm received.	The PROFINET Controller has received a Return of Submodule PROFINET alarm from a PROFINET device.	None.

Group/ Error Code	Description	Cause	Recommended Correction
8-2	PROFINET Submodule replied negatively to Plug configuration.	The PROFINET Controller received a negative acknowledgement while attempting to reconfigure a PROFINET submodule that had been plugged back in to a device.	Attempt reactivation of submodule, by removing the submodule and reinserting it into its host device.
8-3	PROFINET Controller failed delivery of fault to the PACSystems controller.	The PROFINET Controller was unable to deliver to the PACSystems controller a fault that was logged locally on the PROFINET Controller. The fault will appear in the Local Log of the PROFINET Controller but will not appear in the controller Fault Tables.	Contact customer service.
8-5	Failure occurred while processing configuration.	The PROFINET Controller experienced a failure while processing a new configuration. <hr/> Note: <i>The PACSystems controller that delivered the configuration to the PROFINET Controller should also log its own unique failure fault in the Controller Fault Table.</i> <hr/>	Contact customer service.
8-6	PNIO stack asynchronous response error	The PROFINET Controller has experienced a generic error resulting from interactions with the PROFINET Controller stack. Possible causes include two or more messages from the controller stack were not received in the expected order.	This is an informational fault. No action is required.
9-3	Rejected mail error.	The PROFINET Controller received a rejected mail message from the CPU.	Contact customer service.
9-4	Mail processing error on the PROFINET Controller.	The PROFINET Controller encountered an error while processing mail received from the PACSystems CPU (e.g., PROFINET Controller received rejected mail from CPU).	None.
9-7	PROFINET Alarm processing error	The PROFINET Controller has attempted to ACK/NACK a PROFINET Alarm more than once.	This is an informational fault. No action is required.
10-1	Module service request processing error	The PROFINET Controller encountered an error trying to process a Service Request from the CPU (e.g., a request to list all PROFINET devices on the network).	None.

5.8.2 Viewing and Clearing the Local Log Table

The only way to view and clear the data in the Local Log table of the PROFINET Controller is via the Command Line Interface (CLI). As discussed, above, CLI may only be used with the PNC001-Ax module.

- Log data can be viewed via the CLI log or show log commands.
- The Local Log table can only be cleared via the CLI clear log command, which requires Modify level access. Clearing the PACSystems CPU Fault Tables or restarting the PROFINET Controller module does NOT clear the Local Log table.

If the PROFINET Controller Local Log table overflows, new entries overwrite the oldest entries, which are lost. If that happens, the CLI log or show log command indicates the number of entries that have been lost. The count of lost entries is cleared whenever the Local Log table is cleared.

PROFINET Controller Local Log Display

Figure 96 shows a typical display using the log command. The Loc column identifies the device associated with the log entry by its Device Number. PAC Machine Edition assigns a unique Device Number for each Remote IO Device. The Device Number 000 identifies the PNC001 module itself.

Figure 96: Local Log Display

```

pnc>log
IC695PNC001  PROFINET Controller:  Ver. 1.00 (05D1)
Log displayed:          01-JAN-2000  00:17:06.3803
Log Last Cleared:      Log has not been cleared
Number of Entries overflowed:  0
-----
No.   Date       Time           Loc      Description
-----
001  31-DEC-99  23:59:50.8168  000     Module restart - Reason: Power Cycle
002  01-JAN-00  00:01:25.2688  001     Loss of Device.
003  01-JAN-00  00:01:37.3615  001     Add'n of Device.
004  01-JAN-00  00:01:47.6213  001     Loss of I/O Module.
005  01-JAN-00  00:01:51.6448  001     Add'n of I/O Module.
006  01-JAN-00  00:05:39.3407  000     Module restart - Reason: Command Shell
pnc>
```

The command log details provide more information

Figure 97 about all the entries in the Local Log, including the Device Names of remote devices that have log entries. For each PACSystems RX3i CPU, there is a one-to-one correspondence between Device Names and Device Numbers.

Figure 97: Log Details Display

```

Telnet 10.10.0.134
pnc>log details
IC695PNC001 PROFINET Controller: Ver. 1.00 (05D1)
Log displayed:          01-JAN-2000 00:19:15.0332
Log Last Cleared:      Log has not been cleared
Number of Entries overflowed: 0
No.  Date      Time      Loc      Description
-----
001 31-DEC-99 23:59:50.8168 000 Module restart - Reason: Power Cycle
      Device Name Associated with Location
      -----
      Fault Location
      -----
      00.09
      Entry Type      ErrorCode  Group  Action
      -----
      Local Fault      001      002    1
      Extra Data
      -----
      00 01 06 49 00 00 00 00 00 00 00 00 00 00 00 00 00 00 00 00 00 00
No.  Date      Time      Loc      Description
-----
002 01-JAN-00 00:01:25.2688 001 Loss of Device.
      Device Name Associated with Location
      -----
      jfh-et200s
      Fault Location
      -----
      00.09.D001
      EntryType  Circuit  Group  Action  Category  Type  Description
      -----
      I/O Fault  ---      003    2        002      000    000
      Extra Data
      -----
      02 cb 07 63 00 62 00 6c 00 00 00 00 00 00 00 00 00 00 00 00 00 00
  
```

The command log details followed by an entry number displays the information for a single entry. Figure 98 shows the information for log entry 2:

Figure 98: Log Details of a Specific Log Entry

```

Telnet 10.10.0.134
pnc>log details 2
No.  Date      Time      Loc      Description
-----
002 01-JAN-00 00:01:25.2688 001 Loss of Device.
      Device Name Associated with Location
      -----
      jfh-et200s
      Fault Location
      -----
      00.09.D001
      EntryType  Circuit  Group  Action  Category  Type  Description
      -----
      I/O Fault  ---      003    2        002      000    000
      Extra Data
      -----
      02 cb 07 63 00 62 00 6c 00 00 00 00 00 00 00 00 00 00 00 00 00 00
pnc>
  
```

5.9 PROFINET Controller Faults in the PACSystems Fault Tables

The PROFINET Controller logs all (Local, Controller, I/O) faults in its Local Log. In addition, it passes Controller and I/O faults to the PACSystems CPU where they are logged in the corresponding CPU fault Tables (the Controller Fault Table or the I/O Fault Table).

5.9.1 Clearing the PACSystems Fault Tables

- Clearing one or both CPU's fault tables has no effect on the Local Log table in the PROFINET Controller. The Local Log in the PROFINET Controller can only be cleared via a CLI command (applies to PNC001-Ax module only).
- Clearing one or both CPU's fault tables has no effect on the Diagnosis conditions maintained by any IO-Device.
- When the PACSystems CPU's fault tables are cleared, PROFINET-related faults are NOT re-reported, even if the condition that is causing the fault still exists.

5.9.2 Faults Reported to the PACSystems Controller Fault Table

The following PROFINET Controller-related faults are reported in the Controller Fault Table of the PACSystems CPU, in addition to being listed in the Local Log Table of the PROFINET Controller.

Group-Error Code	Description	Cause	Recommended Correction
11-67	Unable to deliver configuration to module.	PROFINET Controller has been configured for feature(s) that are not supported by the version of PROFINET Controller firmware in use	Upgrade the PROFINET Controller to its latest firmware or disable unsupported feature(s) configured for the PROFINET Controller. The features supported for each firmware revision can be found in the <i>RX3i PROFINET Scanner Important Product Information</i> , GFK-2573. This document may be found on the support website.
11-81	Valid module substitution detected.	A module configured for a PROFINET device does not exactly match what is physically present on the device, but the device indicates it is a valid substitution.	The module should operate properly in the presence of this fault. However, to eliminate the fault, try one or more of the following: <ul style="list-style-type: none"> • Make sure the module is installed in the correct location and move if necessary (PNC001 only). • Update the configuration stored to the PROFINET Controller to exactly match the module present. • Replace the module on the device to match the configuration.
11-82	Module configuration mismatch during configuration.	A module configured for a PROFINET device does not match the module that is physically present on the device.	The module will not operate properly, therefore try one or more of the following: <ul style="list-style-type: none"> • Make sure the module is installed in the correct location and move if necessary (PNC001 only). • Update the configuration stored to the PROFINET Controller to equal the actual module present • Replace the module on the device to match configuration.

Group-Error Code	Description	Cause	Recommended Correction
11-83	Module configuration mismatch detected after module hot-insertion.	A module has been hot-inserted into a PROFINET IO-Device, and the physical module detected does not match the configured module.	Either update the configuration stored to the PROFINET Controller to match the module physically present or replace the module on the IO-Device to match the PAC MACHINE EDITION configuration.
11-84	Configured SFP mismatch detected.	SFP configured for a port on the PNC001 does not match what is physically present on the PNC001.	The SFP present should operate properly in the presence of this fault. However, to eliminate the fault, either update the configuration to match the actual SFP type in use, or physically replace the SFP in use with the type of SFP configured.
13-h ¹³	PNC001 hardware failure.	The PNC001 has encountered a hardware related failure.	Contact customer service.
135-s ¹⁴	PNC001 has encountered a critical fatal error.	A critical fatal error has occurred during normal PNC001 operation from which the PNC001 cannot recover.	Contact customer service.
140-i ¹⁵	PNC001 has encountered a non-critical error.	A non-critical error has occurred on the PNC001.	None. This fault is informational.

5.9.3 Faults Reported to the PACSystems I/O Fault Table

The following PROFINET Controller related faults are passed to the PACSystems CPU, where they are reported in the I/O Fault Table of the CPU, in addition to being listed in the Local Log Table of the PROFINET Controller.

¹³ *h* – Error code that provides more information about what part of the PNC’s hardware experienced a failure.

¹⁴ *s* – Error code that provides more information about what caused a fatal error on the PNC.

¹⁵ *i* – Error code that provides more information about a non-critical error.

Group/ Category/ Type/ Descriptor	Description	Cause	Recommended Correction
3-2-0-0	Loss of Device	A configured PROFINET device is no longer present on the network.	<p>If this is unexpected operation, either re-connect missing PROFINET device on the network, or remove the device from the PROFINET Controller's configuration.</p> <hr/> <p>Note: <i>The network connection issue might be in the interconnecting network between the controller and the device, and not necessarily at the device itself. In an MRP ring with many clients, storing a configuration that causes all clients to reconfigure (for example, changing the Domain Name) may generate many Losses/Additions of Device faults. This is the expected behavior, and all devices should automatically return to operational.</i></p> <p>When the critical port is enabled, and the MRC undergoes a reset or download of application logic, this causes Losses/Additions of IO devices connected to it. However, after addition of devices, the operation resumes back to normal.</p>
3-14-0-0	Loss of sub-module on PROFINET device.	A configured PROFINET sub-module is no longer present.	If the submodule is missing, then replace the missing submodule on the device. If the submodule is present, check for a malfunction on the submodule (e.g., loss of field power hardware failure, etc.).
3-14-2-0	PROFINET Device's sub-module under control of PROFINET Supervisor.	A PROFINET Supervisor has taken control of a PROFINET device's sub-module, for which the PROFINET Controller is currently configured and to which it is connected.	If this is unexpected operation, investigate the reason for Supervisor taking control.
3-33-0-0	Loss of network interface on PROFINET device.	A configured network interface on the PROFINET device is no longer present.	Repair or replace the missing or malfunctioning network interface on the device.

Group/ Category/ Type/ Descriptor	Description	Cause	Recommended Correction
3-33-2-0	PROFINET Device's network interface under control of PROFINET Supervisor.	A PROFINET Supervisor has taken control of a PROFINET device's network interface, for which the PROFINET Controller is currently configured and to which it is connected.	If this is unexpected operation, investigate the reason for Supervisor taking control.
3-35-0-0	Loss of network port on PROFINET device.	A configured network port on the PROFINET device is no longer present.	Repair or replace the missing or malfunctioning network port on the device.
3-35-1-0	Expected SFP is missing.	SFP configured for a port on the PNC001 module is not physically present.	Insert SFP into port of PNC001 to match configuration stored to the PNC001 or remove the SFP from PAC MACHINE EDITION configuration.
3-35-2-0	PROFINET Device's network port under control of PROFINET Supervisor.	A PROFINET Supervisor has taken control of a PROFINET device's network port, for which the PROFINET Controller is currently configured and to which it is connected.	If this is unexpected operation, investigate reason for Supervisor taking control.
3-68-1-0	Unsupported SFP detected.	An unsupported (non-Ethernet) SFP is physically connected to a PNC001 port.	The installed SFP is not supported, replace with supported SFP

Group/ Category/ Type/ Descriptor	Description	Cause	Recommended Correction
3-68-2-0	Invalid SFP detected.	An invalid (non-functional) SFP is physically connected to a PNC001 port.	The installed SFP is invalid, replace with a supported SFP
7-3-0-0	Addition of Device.	A configured PROFINET device that was previously missing has just been re-connected.	None. Note: <i>In an MRP ring with many clients, storing a configuration that causes all clients to reconfigure (for example, changing the Domain Name) may generate many Losses/Additions of Device faults. This is the expected behavior, and all devices should automatically return to operational.</i> <i>When the critical port is enabled, the MRC undergoes a reset or a download of application logic, which causes the loss or addition of IO devices connected to it. However, after the loss or addition of devices, the operation resumes normally.</i>
7-15-0-0	Addition of Submodule	A configured PROFINET submodule that was previously reported lost has just been added to the device.	None.
7-15-1-0	Submodule released by PROFINET IO Supervisor	A configured PROFINET submodule that was previously controlled by a PROFINET IO Supervisor has just been released.	None.
7-31-1-0	Extra SFP present on the PNC001.	An SFP port on the PNC001 module has been configured to be empty, but an SFP is present.	Either update the PNC001 configuration to indicate the SFP is present, or physically remove the extra SFP from the PNC001 port.

Group/ Category/ Type/ Descriptor	Description	Cause	Recommended Correction
7-34-0-0	Addition of network interface.	A configured PROFINET interface that was previously reported lost has been added to the device.	None.
7-36-0-0	Addition of network port.	A configured PROFINET port that was previously reported lost has been added to the device.	None.
7-36-1-0	Network port released by PROFINET IO Supervisor.	A configured PROFINET port that was previously controlled by a PROFINET IO Supervisor has been released.	None.
9-6-10-0	Multiple Media Redundancy Managers have been detected on the network.	The PROFINET Controller is configured as a Media Redundancy Manager and other Media Redundancy Managers are currently present on the network.	Update the PROFINET Controller configuration to change its MRP role to either Disabled or Client or remove all the other devices on the network that are also acting as a Media Redundancy Manager.

Group/ Category/ Type/ Descriptor	Description	Cause	Recommended Correction
9-6-11-0	Multiple Media Redundancy Managers are no longer present on the network.	The PROFINET Controller is configured as a Media Redundancy Manager and it had detected that multiple Media Redundancy Managers were on the network, but now those other managers are no longer present.	No action necessary. The network is expected to only have a single Media Redundancy Manager present.
9-6-12-0	The Media Redundancy Manager has detected that the network ring has been broken.	The PROFINET MRP network ring is broken.	The MRP Ethernet ring is broken. Possible causes include damaged or disconnected cable or power loss to a node or switch. Locate and repair the cause(s).
9-6-13-0	The Media Redundancy Manager has detected that the network ring has been repaired.	The PROFINET MRP network ring is closed/okay.	No action necessary. This is the normal, expected state of an MRP Ethernet ring.
9-11-3-1	Invalid MAC address detected.	PROFINET Controller no longer has a valid MAC address.	Contact customer service.

Group/ Category/ Type/ Descriptor	Description	Cause	Recommended Correction
9-11-3-3	Media redundancy configuration error.	The PROFINET Controller has encountered a problem attempting to configure media redundancy operation.	Contact customer service.
9-11-3-4	All critical network ports are disconnected.	The PROFINET Controller has detected that all the configured <i>critical network ports</i> have lost their links and are no longer connected.	Reconnect the configured <i>critical network ports</i> .
9-11-5-z ¹⁶	Internal runtime error.	PROFINET Controller has encountered an internal error during its operation.	Contact customer service.
9-18-1-1	PNC001 module exceeded its recommended operating temperature.	The temperature detected by the PNC001 module has exceeded its safe operating temperature.	Reduce the temperature of the environment where the PNC001 module is operating.
9-18-1-2	Watchdog Timeout Error	PNC001 application code restarted due to a hardware watchdog timeout.	Contact customer service.

¹⁶ z: Runtime error detail. Inform value of z to customer support.

Group/ Category/ Type/ Descriptor	Description	Cause	Recommended Correction
9-69-0-0	PROFINET Controller has become heavily loaded.	The PROFINET Controller has become heavily loaded with activity. PROFINET Controller is running at or above the maximum supported load. I/O updates experienced by the PLC may be slower than optimal. Refer to Section 3.1.1.	<p>No action is required if no PROFINET system performance is observed. If action is required to run the PROFINET Controller at or below the maximum supported load, reduce the load on PROFINET Controller, using one or both of the following methods:</p> <ul style="list-style-type: none"> • Increase the configured update rate value (i.e., IO received less frequently) of one or more PROFINET Devices configured on the PROFINET Controller. • Reduce the number of PROFINET Devices configured on the PROFINET Controller.
9-70-0-0	PROFINET Controller is no longer heavily loaded.	Load applied to PROFINET Controller has been reduced to or below the maximum supported load, after it was previously heavily loaded.	None.

Group/ Category/ Type/ Descriptor	Description	Cause	Recommended Correction
9-71-0-0	Duplicate IP Address detected on the network.	PROFINET Controller has detected a duplicate IP Address on the network. The location associated with the fault will indicate whether the duplication is with the PROFINET Controller itself, or with a configured PROFINET Device.	<p>Either remove the device on the network that has the duplicate IP Address, or assign a new IP Address to either the PROFINET Controller or the conflicting device.</p> <hr/> <p>Note: <i>The Fault Extra Data displays the MAC addresses of the conflicting devices in the MAC 1 field (bytes 8–13) and the MAC 2 field (bytes 14–19). If the PROFINET Controller is one of the devices with a conflicting IP Address, MAC 1 will be 0. This data is stored in Big Endian (most significant byte in lowest address) format.</i></p> <p><i>Also, if the conflict is between PROFINET devices on the network, the DCP Tool can be used to help find the conflict. Sorting by IP Address within the tool may make it easier to identify the duplicates.</i></p>
9-72-0-0	Duplicate IP Address conflict resolved.	PROFINET Controller has detected that a previously duplicated IP Address conflict has been resolved. The location associated with the fault will indicate whether the duplication was with the PROFINET Controller itself, or with a configured PROFINET Device.	None.

Group/ Category/ Type/ Descriptor	Description	Cause	Recommended Correction
28-37-0-0	Unexpected PROFINET Alarm received.	The PROFINET Controller has received a PROFINET alarm that is unexpected. Possible causes could include a malformed PROFINET Alarm packet or an Alarm for a PROFINET sub-module that is not configured.	<p>Consult Device manufacturer documentation.</p> <hr/> <p>Note: Alarm details are provided in the Fault Extra Data. The user should reference Section 5.9.4, PROFINET Fault Extra Data to decode the alarm in the extra data.</p>
28-38-0-0	Manufacturer specific <i>Diagnosis Appears</i> PROFINET Alarm received.	A PROFINET Alarm has been received indicating that a manufacturer specific diagnostic condition has been detected on the PROFINET device.	<p>Consult Device manufacturer documentation.</p> <hr/> <p>Note: Alarm details are provided in the Fault Extra Data. The user should reference Section 5.9.4, PROFINET Fault Extra Data to decode the alarm in the extra data.</p>
28-39-0-0	Manufacturer specific <i>Diagnosis Disappears</i> PROFINET Alarm received.	A PROFINET Alarm has been received indicating that a manufacturer specific diagnostic condition has been resolved on the PROFINET device.	<p>None.</p> <hr/> <p>Note: Alarm details are provided in the Fault Extra Data. The user should reference Section 5.9.4, PROFINET Fault Extra Data to decode the alarm in the extra data.</p>

Group/ Category/ Type/ Descriptor	Description	Cause	Recommended Correction
28-40-x ¹⁷ -0	<i>Channel Diagnosis Appears</i> PROFINET Alarm received.	A PROFINET Alarm has been received indicating that a Channel-level diagnostic condition has occurred on the PROFINET device.	Consult Device manufacturer documentation. Note: Alarm details are provided in the Fault Extra Data. The user should reference Section 5.9.4, PROFINET Fault Extra Data to decode the alarm in the extra data.
28-41-x ¹⁷ -0	<i>Channel Diagnosis Disappears</i> PROFINET Alarm received.	A PROFINET Alarm has been received indicating that a Channel-level diagnostic condition has been resolved on the PROFINET device.	None. Note: Alarm details are provided in the Fault Extra Data. The user should reference Section 5.9.4, PROFINET Fault Extra Data to decode the alarm in the extra data.
28-42-x ¹⁷ -y ¹⁸	<i>Channel Diagnosis Appears</i> PROFINET Alarm received (Alarm contains Extended Channel data).	A PROFINET Alarm has been received indicating that a Channel-level diagnostic condition has occurred on the PROFINET device.	Consult Device manufacturer documentation. Note: Alarm details are provided in the Fault Extra Data. The user should reference Section 5.9.4, PROFINET Fault Extra Data to decode the alarm in the extra data.
28-43-x ¹⁷ -y ¹⁸	<i>Channel Diagnosis Disappears</i> PROFINET Alarm received (Alarm contains Extended Channel data).	A PROFINET Alarm has been received indicating that a Channel-level diagnostic condition has been resolved on the PROFINET device.	None. Note: Alarm details are provided in the Fault Extra Data. The user should reference Section 5.9.4, PROFINET Fault Extra Data to decode the alarm in the extra data.

¹⁷ x: Type value will be equal to the Channel Error Type field of the PROFINET Alarm.

¹⁸ y: Description value will be equal to the Extended Channel Error Type field of the PROFINET Alarm.

Group/ Category/ Type/ Descriptor	Description	Cause	Recommended Correction
28-44-x ¹⁷ -y ¹⁸	<i>Channel Diagnosis Appears</i> PROFINET Alarm received (Alarm contains Qualified Channel data).	A PROFINET Alarm has been received indicating that a Channel-level diagnostic condition has occurred on the PROFINET device.	Consult Device manufacturer documentation. Note: Alarm details are provided in the Fault Extra Data. The user should reference Section 5.9.4, PROFINET Fault Extra Data to decode the alarm in the extra data.
28-45-x ¹⁷ -y ¹⁸	<i>Channel Diagnosis Disappears</i> PROFINET Alarm received (Alarm contains Qualified Channel data).	A PROFINET Alarm has been received indicating that a Channel-level diagnostic condition has been resolved on the PROFINET device.	None. Note: Alarm details are provided in the Fault Extra Data. The user should reference Section 5.9.4, PROFINET Fault Extra Data to decode the alarm in the extra data.
28-46-0-0	<i>Diagnosis Appears</i> PROFINET Alarm received (Alarm contains only Maintenance status).	A PROFINET Alarm has been received indicating that a diagnostic condition has been detected on the PROFINET device.	Consult Device manufacturer documentation. Note: Alarm details are provided in the Fault Extra Data. The user should reference Section 5.9.4, PROFINET Fault Extra Data to decode the alarm in the extra data.
28-47-0-0	<i>Diagnosis Disappears</i> PROFINET Alarm received (Alarm contains only Maintenance status).	A PROFINET Alarm has been received indicating that a diagnostic condition has been resolved on the PROFINET device and maintenance is no longer required.	None. Note: Alarm details are provided in the Fault Extra Data. The user should reference Section 5.9.4, PROFINET Fault Extra Data to decode the alarm in the extra data.

Group/ Category/ Type/ Descriptor	Description	Cause	Recommended Correction
28-48-0-0	<i>Diagnosis Appears</i> PROFINET Alarm received.	A PROFINET Alarm has been received indicating that a diagnostic condition has been detected on the PROFINET device.	Consult Device manufacturer documentation. Note: Alarm details are provided in the Fault Extra Data. The user should reference Section 5.9.4, PROFINET Fault Extra Data to decode the alarm in the extra data.
28-49-0-0	<i>Diagnosis Disappears</i> PROFINET Alarm received.	A PROFINET Alarm has been received indicating that a diagnostic condition has been resolved on the PROFINET device.	None. Note: Alarm details are provided in the Fault Extra Data. The user should reference Section 5.9.4, PROFINET Fault Extra Data to decode the alarm in the extra data.
28-50-0-0	PROFINET Status Alarm received.	A PROFINET Alarm has been received indicating a status change on the PROFINET Device.	Consult Device manufacturer documentation. Note: Alarm details are provided in the Fault Extra Data. The user should reference Section 5.9.4, PROFINET Fault Extra Data to decode the alarm in the extra data.
28-51-0-0	PROFINET Update Alarm received.	A PROFINET Alarm has been received indicating a change to an operating parameter has been made by an external device.	Consult Device manufacturer documentation. Note: Alarm details are provided in the Fault Extra Data. The user should reference Section 5.9.4, PROFINET Fault Extra Data to decode the alarm in the extra data.
28-52-0-0	<i>Port Data Change</i> PROFINET Alarm received (Alarm contains manufacturer specific data).	A PROFINET Alarm has been received indicating a Port change on the PROFINET device.	Consult Device manufacturer documentation. Note: Alarm details are provided in the Fault Extra Data. The user should reference Section 5.9.4, PROFINET Fault Extra Data to decode the alarm in the extra data.

Group/ Category/ Type/ Descriptor	Description	Cause	Recommended Correction
28-53-x ¹⁷ -0	<i>Port Data Error Appears</i> PROFINET Alarm received.	A PROFINET Alarm has been received indicating that a Port Error has occurred on the PROFINET device.	Consult Device manufacturer documentation. <hr/> Note: Alarm details are provided in the Fault Extra Data. The user should reference Section 5.9.4, PROFINET Fault Extra Data to decode the alarm in the extra data.
28-54-x ¹⁷ -0	<i>Port Data Error Disappears</i> PROFINET Alarm received.	A PROFINET Alarm has been received indicating that a Port Error condition has been resolved on the PROFINET device.	None. <hr/> Note: Alarm details are provided in the Fault Extra Data. The user should reference Section 5.9.4, PROFINET Fault Extra Data to decode the alarm in the extra data.
28-55-x ¹⁷ -y ¹⁸	<i>Port Data Error Appears</i> PROFINET Alarm received (Alarm contains Extended Channel Data).	A PROFINET Alarm has been received indicating that a Port Error has occurred on the PROFINET device.	Consult Device manufacturer documentation. <hr/> Note: Alarm details are provided in the Fault Extra Data. The user should reference Section 5.9.4, PROFINET Fault Extra Data to decode the alarm in the extra data.
28-56-x ¹⁷ -y ¹⁸	<i>Port Data Error Disappears</i> PROFINET Alarm received (Alarm contains Extended Channel Data).	A PROFINET Alarm has been received indicating that a Port Error condition has been resolved on the PROFINET device.	None. <hr/> Note: Alarm details are provided in the Fault Extra Data. The user should reference Section 5.9.4, PROFINET Fault Extra Data to decode the alarm in the extra data.

Group/ Category/ Type/ Descriptor	Description	Cause	Recommended Correction
28-57-x ¹⁷ -y ¹⁸	<i>Port Data Error Appears</i> PROFINET Alarm received (Alarm contains Qualified Channel Data).	A PROFINET Alarm has been received indicating that a Port Error has occurred on the PROFINET device.	Consult Device manufacturer documentation. <hr/> Note: Alarm details are provided in the Fault Extra Data. The user should reference Section 5.9.4, PROFINET Fault Extra Data to decode the alarm in the extra data.
28-58-x ¹⁷ -y ¹⁸	<i>Port Data Error Disappears</i> PROFINET Alarm received (Alarm contains Qualified Channel Data).	A PROFINET Alarm has been received indicating that a Port Error condition has been resolved on the PROFINET device.	None. <hr/> Note: Alarm details are provided in the Fault Extra Data. The user should reference Section 5.9.4, PROFINET Fault Extra Data to decode the alarm in the extra data.
28-59-0-0	<i>Port Data Change</i> PROFINET Alarm received (Alarm contains only Maintenance status).	A PROFINET Alarm has been received indicating a Port change on the PROFINET device.	Consult Device manufacturer documentation. <hr/> Note: Alarm details are provided in the Fault Extra Data. The user should reference Section 5.9.4, PROFINET Fault Extra Data to decode the alarm in the extra data.
28-60-0-0	<i>Network Component Problem Alarm Received</i> (Alarm contains manufacturer specific data).	A PROFINET Alarm has been received indicating that a network component has encountered a problem on the PROFINET Device.	Consult Device manufacturer documentation. <hr/> Note: Alarm details are provided in the Fault Extra Data. The user should reference Section 5.9.4, PROFINET Fault Extra Data to decode the alarm in the extra data.

Group/ Category/ Type/ Descriptor	Description	Cause	Recommended Correction
28-61-x ¹⁷ -0	<i>Network Component Problem Appears</i> PROFINET Alarm received.	A PROFINET Alarm has been received indicating that a network component has encountered a problem on the PROFINET Device.	Consult Device manufacturer documentation. <hr/> Note: Alarm details are provided in the Fault Extra Data. The user should reference Section 5.9.4, PROFINET Fault Extra Data to decode the alarm in the extra data.
28-62-x ¹⁷ -0	<i>Network Component Problem Disappears</i> PROFINET Alarm received.	A PROFINET Alarm has been received indicating that a network component problem has been resolved on the PROFINET Device.	None. <hr/> Note: Alarm details are provided in the Fault Extra Data. The user should reference Section 5.9.4, PROFINET Fault Extra Data to decode the alarm in the extra data.
28-63-x ¹⁷ -y ¹⁸	<i>Network Component Problem Appears</i> PROFINET Alarm received (Alarm contains Extended Channel Data).	A PROFINET Alarm has been received indicating that a network component has encountered a problem on the PROFINET Device.	Consult Device manufacturer documentation. <hr/> Note: Alarm details are provided in the Fault Extra Data. The user should reference Section 5.9.4, PROFINET Fault Extra Data to decode the alarm in the extra data.
28-64-x ¹⁷ -y ¹⁸	<i>Network Component Problem Disappears</i> PROFINET Alarm received (Alarm contains Extended Channel Data).	A PROFINET Alarm has been received indicating that a network component problem has been resolved on the PROFINET Device.	None. <hr/> Note: Alarm details are provided in the Fault Extra Data. The user should reference Section 5.9.4, PROFINET Fault Extra Data to decode the alarm in the extra data.

Group/ Category/ Type/ Descriptor	Description	Cause	Recommended Correction
28-65-x ¹⁷ -y ¹⁸	<i>Network Component Problem Appears</i> PROFINET Alarm received (Alarm contains Qualified Channel Data).	A PROFINET Alarm has been received indicating that a network component has encountered a problem on the PROFINET Device.	Consult Device manufacturer documentation. <hr/> Note: Alarm details are provided in the Fault Extra Data. The user should reference Section 5.9.4, PROFINET Fault Extra Data to decode the alarm in the extra data. <hr/>
28-66-x ¹⁷ -y ¹⁸	<i>Network Component Problem Disappears</i> PROFINET Alarm received (Alarm contains Qualified Channel Data).	A PROFINET Alarm has been received indicating that a network component problem has been resolved on the PROFINET Device.	None. <hr/> Note: Alarm details are provided in the Fault Extra Data. The user should reference Section 5.9.4, PROFINET Fault Extra Data to decode the alarm in the extra data. <hr/>
28-67-0-0	<i>Network Component Problem Alarm Received</i> (Alarm contains Maintenance status only).	A PROFINET Alarm has been received indicating that a network component has encountered a problem on the PROFINET Device.	Consult Device manufacturer documentation. <hr/> Note: Alarm details are provided in the Fault Extra Data. The user should reference Section 5.9.4, PROFINET Fault Extra Data to decode the alarm in the extra data. <hr/>

5.9.4 PROFINET Fault Extra Data

An I/O fault table entry contains up to 21 bytes of I/O fault extra data that contains additional information related to the fault. Not all entries contain I/O fault extra data. If the user deploys third-party PROFINET devices, they will need to consult the device manufacturer's documentation. The tables below provide a fault code classification to help users decode the diagnostic fault.

PROFINET Channel Diagnosis Faults

Fault Extra Data Format for the following I/O Fault Categories:		
PNIO_CHAN_DIAG_APPEARS (40) PNIO_CHAN_DIAG_DISAPPEARS (41) PNIO_PORT_DATA_ERR_APPEARS (53) PNIO_PORT_DATA_ERR_DISAPPEARS (54) PNIO_NET_COMP_PROB_APPEARS (61) PNIO_NET_COMP_PROB_DISAPPEARS (62)		
Fault Extra Data Bytes	Field Name	Description
[0] – [1] (WORD)	Alarm Specifier	Alarm Specifier from PROFINET alarm
[2] – [3] (WORD)	Channel Properties	Channel Properties from PROFINET alarm
[4] – [5] (WORD)	Channel Error Type	Channel Error Type from PROFINET alarm
[6] – [16] (BYTE[11])	Extra Data	Unused extra data bytes.
[17] – [20] (DWORD)	Maintenance Status	Maintenance Status from PROFINET alarm (0 if not present)

PROFINET Extended Channel Diagnosis Faults

Fault Extra Data Format for the following I/O Fault Categories:		
PNIO_EXT_CHAN_DIAG_APPEARS (42) PNIO_EXT_CHAN_DIAG_DISAPPEARS (43) PNIO_EXT_PORT_DATA_ERR_APPEARS (55) PNIO_EXT_PORT_DATA_ERR_DISAPPEARS (56) PNIO_EXT_NET_COMP_PROB_APPEARS (63) PNIO_EXT_NET_COMP_PROB_DISAPPEARS (64)		
Fault Extra Data Bytes	Field Name	Description
[0] – [1] (WORD)	Alarm Specifier	Alarm Specifier from Profinet alarm
[2] – [3] (WORD)	Channel Properties	Channel Properties from Profinet alarm
[4] – [5] (WORD)	Channel Error Type	Channel Error Type from Profinet alarm
[6] – [7] (WORD)	Ext Channel Error Type	Ext Channel Error Type from Profinet alarm
[8] – [11] (DWORD)	Ext Channel Add Value	Ext Channel Add Value from Profinet alarm
[12] – [16] (BYTE[5])	Extra Data	Unused extra data bytes.
[17] – [20] (DWORD)	Maintenance Status	Maintenance Status from Profinet alarm (0 if not present)

PROFINET Manufacturer Specific Diagnosis Faults

Fault Extra Data Format for the following I/O Fault Categories: PNIO_MANF_DIAG_APPEARS (38) PNIO_MANF_DIAG_DISAPPEARS (39) PNIO_MANF_PORT_DATA_CHANGE (52) PNIO_MANF_NET_COMP_PROBLEM (60)		
Fault Extra Data Bytes	Field Name	Description
[0] – [1] (WORD)	Alarm Specifier	Alarm Specifier from Profinet alarm
[2] – [3] (WORD)	User Structure Identifier	User Structure Identifier from Profinet alarm
[4] – [16] (BYTE[13])	Manufacturer Data	First 13 bytes of Manufacturer Specific data from Profinet alarm (unused bytes set to 0 if less than 13 bytes of data)
[17] – [20] (DWORD)	Maintenance Status	Maintenance Status from Profinet alarm (0 if not present)

PROFINET Maintenance Faults

Fault Extra Data Format for the following I/O Fault Categories: PNIO_MAINT_DIAG_APPEARS (46) PNIO_MAINT_DIAG_DISAPPEARS (47) PNIO_MAINT_PORT_DATA_CHANGE (59) PNIO_MAINT_NET_COMP_PROB (67) PNIO_DIAGNOSIS_APPEARS (48) PNIO_DIAGNOSIS_DISAPPEARS (49)		
Fault Extra Data Bytes	Field Name	Description
[0] – [1] (WORD)	Alarm Specifier	Alarm Specifier from PROFINET alarm
[2] – [16] (BYTE[15])	Extra Data	Unused extra data bytes.
[17] – [20] (DWORD)	Maintenance Status	Maintenance Status from PROFINET alarm (0 if not present)

PROFINET Qualified Channel Diagnosis Faults

Fault Extra Data Format for the following I/O Fault Categories: PNIO_QUAL_CHAN_DIAG_APPEARS (44) PNIO_QUAL_CHAN_DIAG_DISAPPEARS (45) PNIO_QUAL_PORT_DATA_ERR_APPEARS (57) PNIO_QUAL_PORT_DATA_ERR_DISAPPEARS (58) PNIO_QUAL_NET_COMP_PROB_APPEARS (65) PNIO_QUAL_NET_COMP_PROB_DISAPPEARS (66)		
Fault Extra Data Bytes	Field Name	Description
[0] – [1] (WORD)	Alarm Specifier	Alarm Specifier from PROFINET alarm
[2] – [3] (WORD)	Channel Properties	Channel Properties from PROFINET Alarm
[4] – [5] (WORD)	Channel Error Type	Channel Error Type from PROFINET alarm
[6] – [7] (WORD)	Ext Channel Error Type	Ext Channel Error Type from PROFINET alarm
[8] – [11] (DWORD)	Ext Channel Add Value	Ext Channel Add Value from PROFINET alarm
[12] – [15] (DWORD)	Qualified Channel Qualifier	Qualified Channel Qualifier value from PROFINET alarm
[16] (BYTE)	Extra Data	Unused extra data bytes.
[17] – [20] (DWORD)	Maintenance Status	Maintenance Status from PROFINET alarm (0 if not present)

Unexpected PROFINET Alarm Fault

Fault Extra Data Format for the following I/O Fault Categories: PNIO_UNEXPECTED_ALARM (37)		
Fault Extra Data Bytes	Field Name	Description
[0] – [1] (WORD)	Source File ID	Source file ID where fault was logged.
[2] – [3] (WORD)	Line Number	Source file line number where fault was logged.
[4] – [7] (DWORD)	SCODE	SCODE indicating why the fault was logged.
[8] – [9] (WORD)	Alarm Type	Alarm Type from PROFINET alarm
[10] (BYTE)	Device ID	Configured ID number of PROFINET Device that originated the Alarm.
[11] (BYTE)	API	API number from PROFINET alarm.
[12] – [13] (WORD)	Slot Number	Slot number from PROFINET alarm.
[14] – [15] (WORD)	Subslot Number	Subslot number from PROFINET alarm.
[16] (BYTE)	Reason	An internal reason code for why the fault was logged. Zero means no reason was specified.
[17] – [20] (BYTE[5])	Not Used	Not used – all 0's.

Section 6 Redundant Media

The PACSystems PROFINET Controller supports PROFINET Media Redundancy Protocol (MRP). The PROFINET Controller can be used as either a Media Redundancy Manager or Media Redundancy Client on a redundant media ring.

Media Redundancy enables the network to recover from a failure at any single network link or network node. Because it operates transparently to applications using the network, no changes to the application are needed to use media redundancy.

This Section describes:

- PROFINET Media Redundancy Protocol
- MRP Performance
- Ring Topology with One Controller
- Ring Topology with Multiple Controllers
- Setting Up Media Redundancy Protocol for a PROFINET IO-Controller
- Sequence for Enabling Media Redundancy
- Sequence for Replacing a Media Redundancy Manager
- Procedure for Disabling Media Redundancy

The following table shows which PROFINET Scanners/Devices support MRP.

PROFINET Scanner/Device	Acronym	PROFINET Media Redundancy Protocol (MRP)
RX3i CEP Carrier	RX3i CEP	√
RX3i Genius™ Communications Gateway	RX3i GCG	√
PAC8000 PROFINET Scanner (PNS) Module	PAC8000 PNS	√
RSTi PROFINET Network Adaptor	RSTi PNS	
RSTi-EP PROFINET Network Adaptor	RSTi-EP PNS	√
RX3i PROFINET Scanner (PNS) Module	RX3i PNS	√
VersaMax PROFINET Scanner (PNS) Module	Versamax PNS	√
VersaMax IP PROFINET Scanner Module	VersaMax/IP PNS	√ ¹⁹
VersaPoint PROFINET Scanner	VersaPoint PNS	√

6.1 PROFINET Media Redundancy Protocol

PROFINET Media Redundancy Protocol (MRP) supports devices configured in a ring topology with a maximum of 1 Manager and 63 Clients. It is based on the functions of IEC 62439. Media Redundancy Protocol may not be routed between different IP subnets.

Each device within a Redundant Media network has at least two physical pathways to two other devices on the network. To connect to the ring, each device requires an integrated switch with at

¹⁹ Bumpless operation is only guaranteed at IO Update rates at or above 128 ms

least two external ports (ring ports) that support Media Redundancy Protocol. Devices that are not MRP-capable can be connected to a device like an MRP-capable switch in the ring, but they cannot be in the ring themselves. The redundant paths extend only to the devices on the ring that are MRP capable and enabled.

One of the devices on the ring must be configured as the Media Redundancy Manager (MRM), and all the other devices must be configured as Media Redundancy Clients (MRCs).

The Media Redundancy Manager disables one of the segments of the ring so that a loop is not created in the network. To disable a segment, the Media Redundancy Manager either:

- blocks one of its two Ethernet switch ports used to form the ring when the ring is closed, or
- forwards both switch ports if one of the other ring segments is missing (ring open) and passes messages through the Media Redundancy Manager to get to devices on the other side of the failed segment.

The PROFINET Controller can be used as either a Media Redundancy Manager or Client. The PNS can be used as a Media Redundancy Client.

Typically, one PROFINET Controller module in each ring I/O network is configured as the media redundancy manager. All other nodes in the ring (I/O Devices, network switches, and other PROFINET Controllers) must be configured as media redundancy clients.

6.1.1 MRP Failover Performance

A network using Media Redundancy Protocol recovers from a ring failure within 80 milliseconds when running at 100 Mbps full duplex with default values. Actual failover time depends on the device responsiveness to network disconnection and reconnection, number of devices in the ring, media speed, length of media, and frequency of sending test frames over the network. Network recovery time is shorter with fewer devices, faster media speed, and shorter media lengths. If all MRC devices provide LinkUp/LinkDown indications, the network recovery time will be significantly shorter than 80ms. Third-party devices in the MRP ring may introduce additional network recovery time.

When MRCs do not provide LinkUp/LinkDown detection, network recovery time also depends upon the test packet timeout interval, which is the product of the Default Test Interval and the Test Monitoring Count plus 1 that have been set for the Media Redundancy Manager. These parameters determine the frequency for network integrity checks and the number of failed integrity checks to allow before declaring a ring failure. For a PACSystems PROFINET Controller acting as Media Redundancy Manager, these parameters are set as part of the PAC Machine Edition hardware configuration. (For example, the default test packet timeout interval is $20 \text{ ms} \times (3+1) = 80 \text{ ms}$.)

Each device in the ring must be able to detect the failure or recovery of a connection. When using third-party devices in a redundant media ring, failover time will be affected by the performance of these devices. For devices that do not detect the failure or recovery of a connection via LinkUp/LinkDown indication, the shortest guaranteed failover time will be the test packet timeout interval, as described above.

For bumpless network recovery (without disturbing I/O communications to an I/O Device), the Update Rate for the I/O Device should be configured to be greater than 1/2 of the network recovery time. This permits the ring to be disconnected or reconnected without timing out the communication connection between the I/O Device and its I/O Controller.

1000Base-T SFPs on a PNC001 module can introduce significant network recovery time. For best MRP performance with a 10/100/1000 Mbps copper Ethernet MRP ring network, configure the

RJ45 Ethernet ports (Ports 1 and 2) as MRP ring ports instead of those SFP ports (Ports 3 and 4) with 1000Base T SFPs.

Note: *The 1000BaseT SFPs qualified for use with the RX3i PNC001 module can only detect a ring break when running at 1 Gbps at the IEEE 802.3 Clause 40 standard requirement of 750ms. In order to experience bumpless I/O at a 16ms I/O Update rate with these SFPs at 1 Gbps, the MRM must be configured with a Test Packet Interval of 10ms and a Test Packet Count of 2.*

6.1.2 Bumpless Operation with MRP

The PROFINET Controller supports bumpless operation with Emerson PROFINET I/O Devices if and only if specific conditions are met. Bumpless operation means that a single break in an MRP ring will not cause the PROFINET connection to be lost and there is no observed loss and addition of PROFINET I/O Devices while the ring network recovers.

Without bumpless MRP, when a device is lost, it must be re-acquired by the I/O Controller; a typical recovery time is on the order of seconds.

There are two ways an MRM detects a break in the ring:

- A message from an MRC that provides LinkUp/LinkDown detection
- Use of a test packet timeout interval

A network using Media Redundancy Protocol recovers from a ring failure within 80 milliseconds when running at 100/1000 Mbps full duplex with default Media Redundant Manager (MRM) test packet values. Actual failover time depends on the device responsiveness to network disconnection and reconnection, number of devices in the ring, media speed, length of media, and frequency of sending test frames over the network. Network recovery time is shorter with fewer devices, faster media speed, and shorter media lengths. Third-party devices in the MRP ring may introduce additional network recovery time. Network recovery time is limited by the ring participant with the slowest ring failure recovery time. Devices that do not provide LinkUp/LinkDown detection should be considered when calculating network recovery time.

For bumpless network recovery (without disturbing IO communications to an I/O-Device), the I/O Update Rate for the I/O-Device should be configured to be greater than 1/2 of the network recovery time. This permits the ring to be disconnected or reconnected without timing out the communication connection between the I/O Device and its I/O-Controller.

In order to insure correct MRP operation, it is important to connect the correct Ethernet ports of the PROFINET Controller and devices to the MRP ring. The ports connected to the ring must be the same ports configured as MRP Ring Ports. Failure to connect the configured ports will prevent the PROFINET Controller and devices from correctly participating in the MRP ring.

Disclaimer: Pulling a fiber SFP cable out of the SFP cage (as opposed to cutting a fiber cable), can have unpredictable performance (and may lose devices in a properly configured MRP ring) due to the fact that the light is still seen by the SFP as the cable is being removed so that data is lost significantly before the SFP can detect that the connection has been lost.

6.1.3 MRP Operation for I/O Update Rates of 16ms or Greater

The PACSystems RX3i PROFINET IO Controller supports bumpless operation at 16ms with the requirement that the MRP Manager be configured for an MRP Test Packet Interval and MRP Test Packet Count that is faster than the fastest IO timeout possible.

For example:

Assume the worst-case scenario when a ring break occurs immediately after the device received a test packet and immediately before the device was scheduled to receive an I/O packet. In the case of a 16ms I/O Update Rate, a timeout will occur after three consecutive missed I/O packets, which can occur in slightly over 32ms. If the Test Packet Interval is configured for 10ms and the Test Packet Count is configured for 2, the PROFINET Controller can detect a ring break in just less than 30ms. This ring recover scenario would look like the following timeline.

Figure 99: Timeline for Successful MRP Ring Repair at 16ms I/O Update Rate

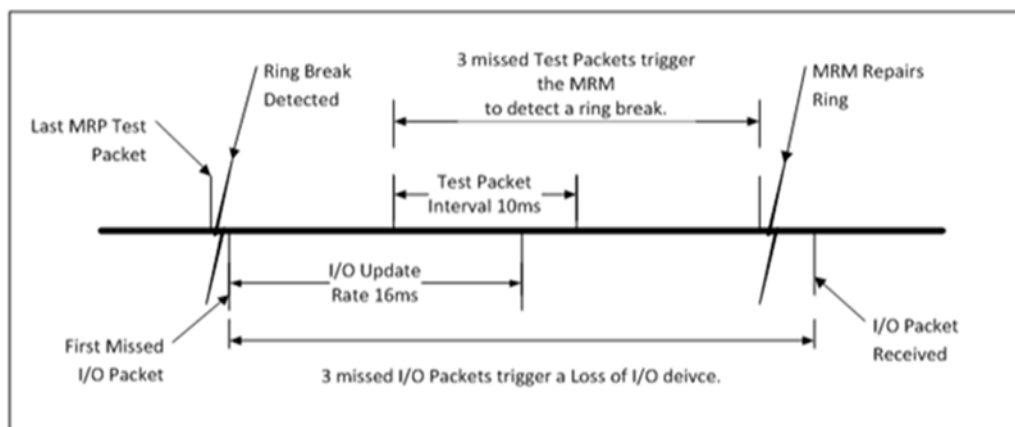

To ensure a successful ring recovery using the Test Packets at a 16ms I/O Update rate or above, make sure the following statement is true:

$$\text{Test Packet Interval} \times (\text{Test Packet Count} + 1) < \text{I/O Update Rate} \times 2$$

6.1.4 MRP Operation at I/O Update Rates Less Than 16ms

The PACSystems implementation of MRP supports fast LinkUp/LinkDown detection on devices, an optional part of the MRP standard. This allows an MRC experiencing a network link failure or recovery to send LinkUp/LinkDown messages to the MRM immediately. The MRM can heal the network without needing to wait for multiple test-packet timeouts to detect the failure. This feature allows the network recovery time to be significantly shorter than the test packet timeout interval because the break is detected immediately.

6.1.5 Minimum I/O Rate When Configured in an MRP Ring

The minimum I/O rate that is possible for bumpless operation depends on the speed and the type of physical connection being used for the MRP ring ports. PACSystems PROFINET I/O Controllers support a specified number of PACSystems PROFINET I/O devices running at or above the minimum I/O Update Rate listed in the table below.

6.1.6 Minimum I/O Update Rates for Bumpless Operation in an MRP Ring Topology

If your application requires the PROFINET IO to operate in a bumpless fashion (i.e., experience no Loss of Device faults and no defaulting of IO) whenever a break in the ring occurs, then the IO Update Rates of all the devices in that ring must be no smaller than the Minimum IO Update Rate described in this table.

When no third-party items participate in the ring:			
Ring Port Usage	I/O-Devices in the Ring	Minimum I/O Update Rate (ms)	Additional Media Redundancy Manager Requirements
PNC001 Ports 1 & 2 both operating at 100 Mbps	VersaMax PNS and/or RX3i CEP	1	None

When no third-party items participate in the ring:			
	An RX3i PNS (or RX3i GCG) using Port 1 & Port 2 for ring	2	None
	An RX3i PNS using Port 3 or Port 4 for the ring	16	Set Default Test Interval to 10ms. Set Test Monitoring Count to 2.
	PACMotion VFD with PROFINET Card	16	
	An RSTi-EP PNS	32	
CPL410/CPE330/CPE400 Embedded PROFINET (LAN2): Both Ports operating at 100 Mbps	VersaMax PNS and/or RX3i CEP	8	None
	PACMotion VFD with PROFINET Card	16	Set Default Test Interval to 10ms. Set Test Monitoring Count to 2.
	An RX3i PNS (or RX3i GCG) using Port 1 & Port 2 for ring	8	None
PNC001 Port 1 or Port 2 operating at 1000 Mbps	An RX3i PNS, VersaMax PNS and/or RX3i CEP, or RX3i GCG	16	Set Default Test Interval to 10ms. Set Test Monitoring Count to 2.
PNC001 Port 3 or Port 4 operating at any speed			
CPL410/CPE330/CPE400 Embedded PROFINET (LAN2): Either Port operating at 1000 Mbps			
	PACMotion VFD with PROFINET Card	16	
	An RSTi-EP PNS	32	
CPE100/CPE115 Embedded PROFINET (LAN2): Port 2 & Port 3 operating at 100Mbps	An RX3i PNS, VersaMax PNS and/or RX3i CEP, or RX3i GCG	16	None
	An RSTi-EP PNS	32	
EPXCPE205/210/215/220/240 Embedded PROFINET (LAN2): Both ports operating at 100 Mbps	An RX3i PNS, VersaMax PNS and/or RX3i CEP, or RX3i GCG	16	Set Default Test Interval to 10ms. Set Test Monitoring Count to 2.
	An RSTi-EP PNS	8	

When no third-party items participate in the ring:			
EPXCPE205/210/215/220/240 Embedded PROFINET (LAN2): Both ports operating at 1000 Mbps	An RX3i PNS, VersaMax PNS and/or RX3i CEP, or RX3i GCG	32	None
	An RSTi-EP PNS	32	
If any third-party items participate in the ring, the minimum I/O Update Rate is the larger of the following two options, regardless of which ports are used for the ring:			
<ul style="list-style-type: none"> • The smallest I/O Update Rate selectable within PAC MACHINE EDITION that is more than 1/2 of the largest worst-case ring recovery time among the third-party items. For example, if the manufacturer states that the worst-case ring recovery time is 96ms, the rate needs to be more than 96ms divided by 2, which is 48ms. The next available rate above 48ms is 64ms. • 16ms I/O Update Rate. When using an I/O Update Rate of 16ms, set the Default Test Interval to 10ms and the Test Monitoring Count to 2 on the Media Redundancy Manager. 			

6.1.7 MRP Ring Ethernet Traffic Storm Prevention

The LAN2 Ethernet ports used for the embedded IO-Controller function in CPL410, CPE400, CPE330, CPE205/2120/215/220/240 and CPE100/CPE115 may be used as an MRP Ring Manager (MRM). Since LAN2 defaults to be an Ethernet switch, it is required that the physical ring must not be connected until an MRM configuration has been stored to any Ethernet node on the ring, including to LAN2 on CPL410, CPE400, CPE330, CPE205/2120/215/220/240 or CPE100/CPE115.

Failure to have an active MRM configured in an Ethernet ring will result in an Ethernet traffic storm caused by the ring's network loop topology. The Ethernet traffic storm will prevent communication to all Ethernet nodes connected to the ring until the ring is broken or an MRM is configured.

The CPL410, CPE400, CPE330, CPE205/2120/215/220/240 and CPE100/CPE115 maintain their MRM statuses after a hardware configuration clear and until they are subjected to a power cycle. After clearing the hardware configuration, and before power-cycling a CPU that was configured as an MRM in a ring topology, it is recommended that either:

- a. The ring be physically broken by disconnecting an Ethernet port on any network node in the ring, or
- b. Any other network node in the ring be configured as an MRM.

6.1.8 Third-party MRP Manager Use with PROFINET Controller as MRP Client

When using a third-party MRP Manager, it is recommended to set the MRP Manager Test Monitoring Interval to 10ms and Test Monitoring Count to 2 and/or connect the PROFINET Controller client directly to a device that provides fast link down detection.

Failure to follow these recommendations may result in degraded MRP Ring update performance for bumpless operation, due to the speed at which ring breaks are detected.

Use the tables below as a guide when choosing not to follow the recommendations.

CPE100/CPE115 Embedded PROFINET IO-Controller Ring Port Connection	Minimum Recommended I/O Update Rate(ms)
Cu Fixed Ports @100Mbps	16

CPE330/CPE400/ CPL410/CPE330, Embedded PROFINET IO-Controller Ring Port Connection	Minimum Recommended I/O Update Rate(ms)
Cu Fixed Ports @100Mbps	8
Cu Fixed Ports @1Gbps ²⁰	64

CPE205/210/215/220/240 Embedded PROFINET IO-Controller Ring Port Connection	Minimum Recommended I/O Update Rate(ms)
Cu Fixed Ports @100Mbps	8
Cu Fixed Ports @1Gbps ²¹	64

PNC001 Ring Port Connection (Port Type or SFP Type)	Minimum Recommended I/O Update Rate (ms)
Cu Fixed Ports @100Mbps	2
Cu Fixed Ports @1Gbps	512
Cu SFP @100Mbps	4
Cu SFP @1Gbps	512
100Base FX SFP (MMF) – 100Mbps	16
100Base LX10 SFP (SMF) – 100Mbps	16
1000Base SX SFP (MMF) - 1Gbps	32
1000Base LX SFP (SMF) - 1Gbps	64
1000Base ZX SFP (SMF) - 1Gbps	64

Disclaimer: Performance numbers for SFPs are with Emerson branded SFPs, or are supported / tested only with Avago or Finisar vendors. Other vendors may produce varying performance results.

²⁰ Note that if the port is configured as a Critical Network Port, the data rate is forced to 100Mbps. This results in the minimum update rate as indicated in the row above. For further details, refer to Critical Network Ports in Section 3.6.2.

6.2 Ring Topology with One Controller

The following diagram illustrates a simple ring topology with one RX3i CPU Node and three I/O Devices on the same PROFINET network. In Figure 100: Ring Topology with One Controller, the PROFINET Controller module in the RX3i controller is configured to be the Media Redundancy Manager and the I/O Devices, in this case PNS modules, are configured to be Media Redundancy Clients.

Figure 100: Ring Topology with One Controller

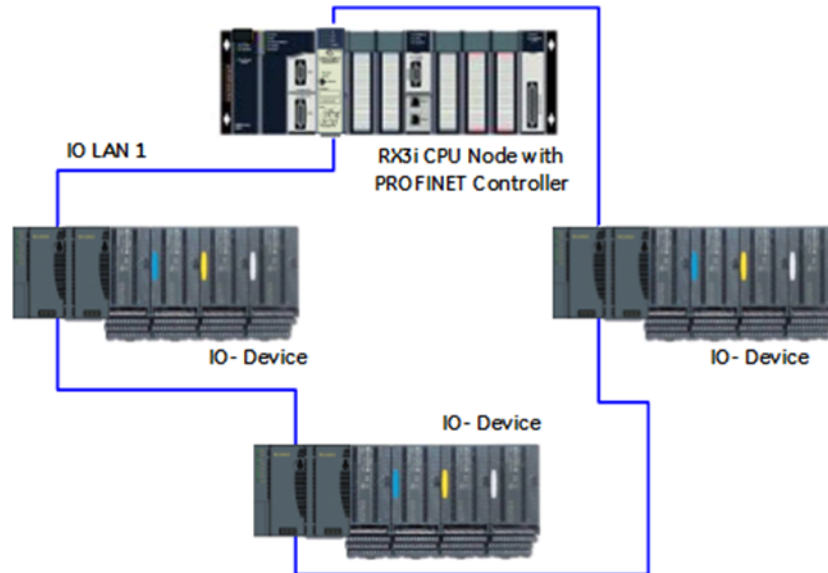

As a Media Redundancy Manager, the PROFINET Controller detects when the network ring has been broken and repaired. Each time the PROFINET Controller detects that the ring has been broken or repaired, a fault is reported in the Local Log table and that condition is passed to the RX3i CPU to be registered in the CPU fault table. In addition, the PROFINET Controller keeps a count of break/repair detections. In the PNC001-Ax module, this may be viewed via the CLI `show rdnmedia` command.

As a Media Redundancy Manager, the PROFINET Controller detects whether another Media Redundancy Manager is on the same ring. If more than one Media Redundancy Manager is present on the same ring, the PROFINET Controller logs an entry in its Local Log table and passes the fault to the RX3i CPU fault table. Upon detecting that there are no longer multiple Media Redundancy Managers on the ring, the PROFINET Controller logs a fault in the Local Log and passes this to the RX3i CPU to be registered in the CPU fault table. This indicates that the previously invalid setup has subsequently been resolved.

6.3 Ring Topology with Multiple Controllers

Figure 101 shows a more complex network. There is one RX3i CPU node with two PROFINET Controllers, a second RX3i CPU node with one PROFINET Controller, and five I/O Devices, in this case, PNS modules. The PROFINET Controllers depicted are PNC001 modules but could be embedded PROFINET Controllers.

All devices are on the same network ring. One PROFINET Controller is configured as the Media Redundancy Manager (MRM); the other PROFINET Controllers and all PROFINET Scanners are configured as Media Redundancy Clients (MRCs).

Figure 101: Ring Topology with Multiple Controllers

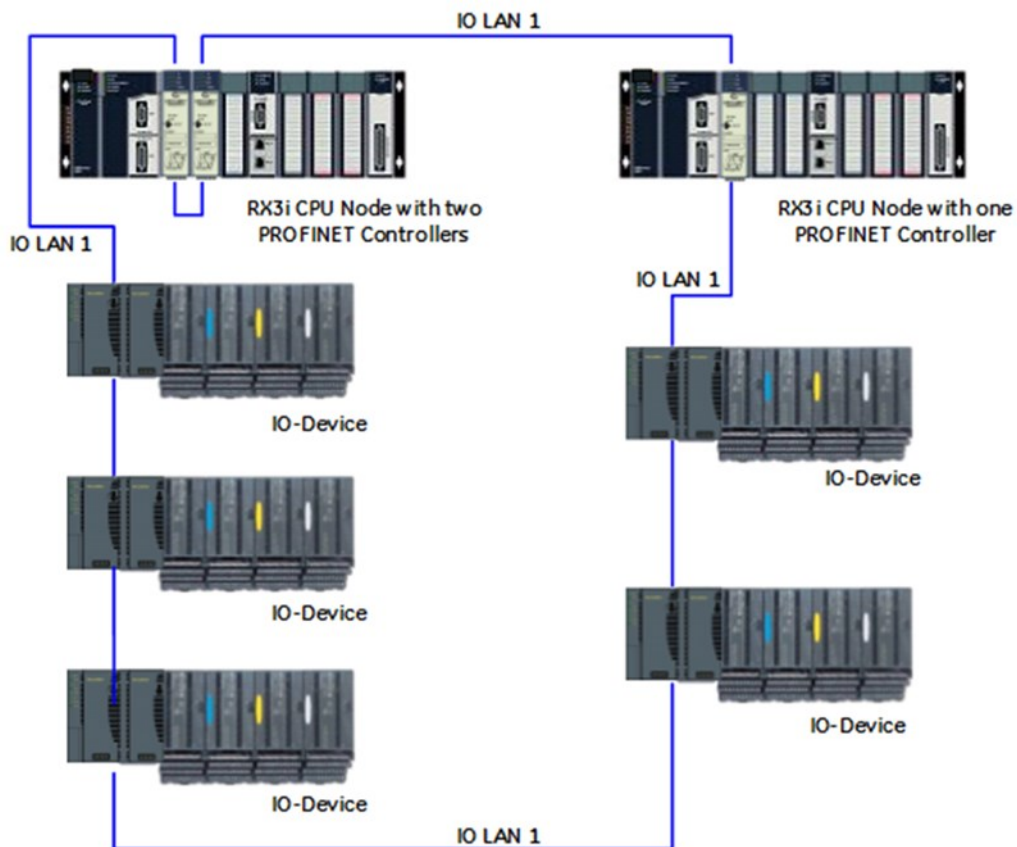

6.4 Setting Up Media Redundancy Protocol

Media Redundancy must first be set up in the hardware configuration of all devices on the LAN. Instructions for configuring Media Redundancy using PAC Machine Edition are in Section 3 Configuration.

Only one device on the ring can be configured as the Media Redundancy Manager. All other devices on the ring must be configured as Media Redundancy Clients.

6.4.1 Media Redundancy Setup for a PROFINET Controller

A PROFINET Controller can be configured as either a Media Redundancy Manager (MRM) or a Media Redundancy Client (MRC). By default, Media Redundancy is disabled for the PROFINET Controller. To be used, it must first be enabled and set up in the configuration.

Configuring a Media Redundancy Manager includes specifying a test interval and retry count for ring failure checking. It also includes specifying which of the ports on the PROFINET Controller are connected to the ring.

The PROFINET Controller stores the current Media Redundancy Protocol configuration settings in non-volatile storage so it can configure the switch port appropriately at power-up. The PROFINET Controller disables all its external Ethernet ports until it has retrieved and applied the Media Redundancy Protocol configuration from its non-volatile storage.

If a configuration containing a PROFINET Controller set up as a Media Redundancy Manager is subsequently used to generate another configuration, using Generate Secondary Hardware Configuration from the Current Configuration, for example, the PROFINET Controller configuration in the copy is automatically defaulted to a Media Redundancy Client.

6.5 Sequence for Enabling Media Redundancy

To avoid network loops occurring before the Media Redundancy configuration parameters are stored, the network must first be set up with the ring broken at one point. Otherwise, packets could continuously cycle on the network and use up significant network bandwidth. The ring should not be closed until the Media Redundancy configuration parameters are successfully stored to the Media Redundancy Manager and the Media Redundancy Manager is operational.

If more than one Media Redundancy Manager is present on the same ring, each PROFINET Controller that is configured as a Media Redundancy Manager will log a fault in its Local Log and in the RX3i CPU's I/O Fault Table. When the RX3i configuration is cleared, the Media Redundancy configuration parameters (Media Redundancy Manager or Client) are kept until a new setting is stored. If power is lost, the Media Redundancy configuration settings are preserved.

Note: *When configuring a Media Redundancy Manager in an open ring, the module may initially report the ring to be closed. This indication will immediately be followed by a ring open event. This is expected behavior defined by the MRP specification.*

6.6 Sequence for Replacing a Media Redundancy Manager

If it is necessary to replace the PROFINET Controller that is serving as the Media Redundancy Manager, the replacement module must be set up as a Media Redundancy Manager before adding it to the ring. Alternatively, the ring must be opened before powering up the new module and adding it to the network, as described above.

The following procedure can be used to replace a PNC001 module that is operating as Media Redundancy Manager without disrupting the network.

1. Verify that the ring has no breaks in it, or that the only break involves the Media Redundancy Manager itself. If the ring is already broken someplace else, the Media Redundancy Manager must always remain operational or connectivity between the remaining devices is not guaranteed.
2. Physically disconnect both ring's network connections from the PNC001 module that is serving as the Media Redundancy Manager.
3. Remove the disconnected PNC001 module from the RX3i rack.
4. Using the Machine Edition programmer, make sure the configuration encompassing the removed PNC001 module is stored to the RX3i CPU.
5. Insert the replacement PNC001 module into the RX3i rack in the allocated slot.
6. Using the Machine Edition programmer, view the Fault Tables to make sure the PNC001 module is configured correctly.
7. Physically reconnect both ring's network connections to the replacement PNC001 module.

6.7 Procedure for Disabling Media Redundancy

When disabling Media Redundancy, the ring must be physically opened before storing configuration to the modules. Here is the procedure to successfully disable Media Redundancy on a network.

1. If the ring has no breaks in it, physically disconnect one (and only one) of the ring's network connections from the PROFINET Controller that is currently serving as the Media Redundancy Manager.
2. Change the configuration for the device that is the Media Redundancy Manager so that it will no longer serve as the Media Redundancy Manager. If an RX3i PROFINET Controller is the Media Redundancy Manager, use PACs Machine Edition to disable the Media Redundancy role on that PROFINET Controller and then to download the hardware configuration (If a third-party I/O controller is the Media Redundancy Manager, the appropriate third-party configuration tool must be used instead).

Section 7 Network Management

The PROFINET Controller supports the SNMP (Simple Network Management Protocol) and LLDP (Link Layer Discovery Protocol) standards to facilitate network management.

This Section describes:

- SNMP
 - Overview of SNMP
 - Supported SNMP Features
 - SNMP Read Access
 - SNMP Write Access
 - MIB-II Groups Supported
 - MIB-II System Group Values
- LLDP
 - Overview of LLDP
 - LLDP Operation
 - LLDP TLV Structures

7.1 SNMP

The built-in SNMP (Simple Network Management Protocol) Server/Agent function on the PROFINET Controller can be used by a third-party SNMP Client or Network Management Station to access network data.

7.1.1 Overview of SNMP

SNMP is a UDP-based network protocol that facilitates the exchange of management information between network devices. An SNMP-managed network consists of three key components: managed devices, agents, and network management systems (NMS).

A managed device is a network node that contains an SNMP agent and that resides on a managed network. Managed devices exchange management information with NMSs via their local agent.

An agent is a network management software module that resides on a managed device. An agent maintains a collection of management information that it provides in an SNMP-compatible format upon request to NMSs.

An NMS executes applications that monitor and control managed devices.

The collections of management information maintained by agents and managed devices are generally referred to as Management Information Bases (MIBs). A MIB is a collection of information organized into a hierarchical structure where related items are grouped together in “groups.” MIBs are used to organize and standardize the management information on agents and can be accessed via commands provided within the SNMP protocol.

The SNMP protocol is currently defined by five protocol specifications: SNMPv1, SNMPv2, SNMPv2c, SNMPv2u, and SNMPv3.

NMSs use four basic classes of SNMP commands to retrieve and alter data on managed devices

- The read (GET) command is used by an NMS to monitor managed devices through examination of the values of different variables maintained within the managed devices’ MIBs.
- The write (SET) command is used by an NMS to control devices through modification of the values maintained by the managed devices within their MIBs.
- The trap (TRAP, INFORM) command is used by an NMS to get asynchronous notifications when certain events occur on managed devices. In SNMP Version 2, traps are not set via the protocol but are defined at the managed device by local action.
- Traversal operations (GETNEXT and GETBULK) are used by an NMS to determine which variables a managed device supports and to sequentially gather information from the MIBs.

SNMP is a well-defined protocol; additional information is available in the literature and on the World Wide Web.

7.1.2 Supported SNMP Features

The PROFINET Controller supports:

- SNMPv1 and SNMPv2c
- MIB-II (see RFC 1213 for details)
- LLDP MIB (see IEEE 802.1AB for details)
- LLDP 802.3 Extension MIB (see IEEE 802.1AB for details)

The PROFINET Controller does not:

- Support SNMPv3.
- Provide asynchronous notifications via SNMP.
- Generate SNMP TRAP or INFORM messages.

7.1.3 SNMP Read Access

SNMP provides standard commands that allow a client to read SNMP data. The PROFINET Controller supports these commands:

GET
GETNEXT
GETBULK

The SNMP Community strings supported for read access are:

- public²¹
- pub¹⁸
- icmp¹⁸
- private¹⁸
- priv¹⁸
- ge_pnc²² (For RX3i PNC001)
- G3_PnC001 (For Embedded PNCs)

These community strings are fixed and cannot be changed.

7.1.4 SNMP Write Access

SNMP should not be used to change parameters on the PROFINET Controller module.

- For PNC001 firmware version 2.05 and earlier, the SNMP SET command succeeds for the variables in some MIBs/groups but fails for the variables in other MIBs/groups. Changes made using SNMP SET change only the SNMP variable itself, do not affect the PNC001 module operation, and are not saved across a power-cycle or restart. For example, setting the sysName variable from the System Group does not change the Device Name of the PNC001 module.
- The SNMP Set command for PNC001 firmware version 2.10 and later is disabled
- SNMP Write Access is disabled in all models with Embedded PROFINET.

7.1.5 MIB-II Groups Supported

The PROFINET Controller supports all the mandatory values in the following groups of the MIB-II specification:

- System group
- Interfaces group
- IP group
- ICMP group
- TCP group
- UDP group

²¹ Requires PNC firmware version 2.05 or later.

²² Requires PNC firmware version 2.10 or later.

- Transmission group (802.3 Ethernet subset)
- SNMP group

The EGP group and Address Translation group of MIB-II are not supported.

The meanings of the values in these groups are well defined in the standard literature. However, the contents of some values are implementation-specific. This section explains contents of values specific to the PROFINET Controller.

Interface Number

Many MIB-II groups use an SNMP interface number to refer to a device port. For the PROFINET Controller module, the interface numbers are:

Physical Port	SNMP Interface Number
External Port #1	1
External Port #2	2
External Port #3	3
External Port #4	4
Internal Data Port	5

MIB-II Interface Group Values

For the MIB-II Interface Group, the ifDescr value provides a textual description of the corresponding interface/port. The values returned for that item are the same as the port numbers listed above.

The counters ifInDiscards and ifInUnknownProtocols are always reported as zero.

7.1.6 MIB-II System Group Values

Many of the items provided by the MIB-II System Group are implementation-specific. The values that are returned for the PROFINET Controller are described in the following table.

Name	Value
sysDescr	Text description of the device being managed. For example: Emerson PROFINET IO-Controller, IC695PNC001
sysObjectID	Uniquely identifies the kind of device being managed. The first part of the value returned (1.3.6.1.4.1.24893) indicates that this is an Emerson device. The two numbers after that (1.5) indicate that it is a product made for the Control Systems Business. The three numbers after that identify (in order): <ul style="list-style-type: none"> • Family: RX3i = 1; RST-EP = 2 • Product: PROFINET Controller = 2 • Model: (specific to each Family/Product combination) For the RX3i PNCr: 1.3.6.1.4.1.24893.1.5.1.2.1 For the RSTi-EP CPE200 Series Embedded PNC: 1.3.6.1.4.1.24893.1.5.2.2.1
sysContact	Nothing (empty string)
sysName	The <i>Device Name</i> assigned to the node. If the <i>Device Name</i> hasn't been assigned yet, an empty string is returned.
sysLocation	Nothing (empty string)
sysServices	79 (0x4F) This value indicates the PROFINET Controller has Layers 1–4 (physical, datalink, network, and transport) and Layer 7 (application) functionality.

7.2 LLDP

The PROFINET Controller implements the Link Layer Discovery Protocol (LLDP). A PROFINET IO-Supervisor or other network host may use LLDP to discover the PROFINET network.

7.2.1 Overview of LLDP

The Link Layer Discovery Protocol is an IEEE standardized protocol used by network devices to advertise their identities and capabilities and receive that information from physically adjacent link layer peers.

LLDP data packets are sent by devices from each of their interfaces at fixed intervals. The LLDP packets are multicast and are not forwarded by network switches.

Each LLDP packet consists of one LLDP Data Unit (LLDPDU). Each LLDPDU is a sequence of Type-Length-Value (TLV) structures.

LLDP Data Unit Contents

Chassis ID TLV structure (mandatory, always first)
Port ID TLV structure (mandatory, always second)
Time to Live TLV structure (mandatory, always third)
Optional Structures (any number of these, in any order)

End of PDU TLV (mandatory, always last)

7.2.2 LLDP Operation

The LLDP agent in the PROFINET Controller multicasts LLDP messages to the network at 5 second intervals, or when a change occurs in any of the local data that is delivered within the LLDP message. The LLDP messages are transmitted from each external port that is connected to a network.

7.2.3 LLDP TLVs

The following is a brief description of the RX3i PROFINET Controller LLDP TLVs.

Chassis ID TLV

The Chassis ID is always the first TLV in the LLDPDU. Chassis ID identifies the device on the network. PROFINET defines two possible Chassis ID formats; each format has a different Chassis ID subtype. The PROFINET Controller generally uses the Name of Station (NOS) as the Chassis ID. If for some reason the station name is changed to the empty string "", the internal MAC address is used instead.

ID Subtype	Meaning	Value
7	PNIO Chassis ID	Name of Station (character string)
4	MAC Address	Internal MAC Address of Ethernet controller

Port ID TLV

The Port ID is always the second TLV in the LLDPDU. The Port ID identifies the individual network port on the device. PROFINET defines the Port ID as a character string.

ID Subtype	Meaning	Value
7	PNIO Port ID	"port-PPP-SSSSS" (length = 14 bytes)

PPP specifies the decimal port number in the range 001 to 004. SSSSS specifies the decimal slot number of the Controller in the range 00000 to 65535.

Time to Live TLV

Time to Live is always the third TLV in the LLDPDU. Time to Live specifies the number of seconds that the information in this LLDPDU remains valid after delivery on the network. A Time to Live value of 0 instructs the receiver to immediately invalidate the data in this LLDPDU and is issued when the PROFINET Controller has changed a parameter that is advertised in its LLDP.

The PROFINET Controller sets the Time to Live value to 20 seconds.

End of PDU TLV

The End of PDU TLV is always the last TLV in the LLDPDU. This TLV carries no device information.

PROFINET Port Status TLV

The PROFINET Port Status TLV indicates the current PROFINET status of the network port over which this LLDP message is sent. Since the PROFINET Controller does not support RT Class 2 or RT Class 3, the subfields are set to off (0x0000).

PROFINET MRP Port Status TLV

The PROFINET MRP Port Status indicates the current MRP status of the network port over which this LLDP message is sent.

This TLV is required when the LLDP sender is an MRP port. It is not present in the LLDP packet issued from a non-MRP port.

The PROFINET Controller supports the following values:

Subfield	Value
MRP Domain ID	Contains the MRP domain UUID. Assigned internally by the network node. Set to 0xFFFFFFFF-FFFF-FFFF-FFFF-FFFFFFFFFFFFFF.
MRRT Port Status	0x00 = Off / Not Used

PROFINET Chassis MAC TLV

The PROFINET Chassis MAC indicates the internal MAC address used by the PROFINET stack. This is not the MAC address of any individual network port.

MAC/PHY Config/Status TLV

The MAC/PHY Configuration/Status indicates the supported auto-negotiation capability, the current negotiated capability, and the Medium Attachment Unit (MAU) type of the network port over which this LLDP message is sent.

Field	Values	RX3i PROFINET Controller
Auto-negotiation Support/Status	Bit 0: Auto-negotiation supported (1= Yes, 0 = No) Bit 1: Auto-negotiation status (1 = Enabled, 0 = Disabled) Bits 2-7: Reserved	0x03 (Auto-negotiation supported and enabled)
Auto-negotiation Advertised Capability	Note: There are no AutoNegCapability definitions for 100Base FX or LX (HD or FD). A device that supports these must advertise "Other."	Copper Ports: 0x6C03 = 10/100/1000T HD+FD SFP Ports: (Depends on SFP type) 0x000C = 1000 LX/SX HD+FD 0x6C03 = 10/100/1000T HD+FD 0x8000 = Other (100 FX, LX) SC Fiber Ports: 0x8000 = Other (100 FX)
Operational MAU Type	Typical values are: 0x000B: 10BaseT FD 0x0010: 100BaseTX FD 0x0012: 100Base FX FD (Multi-mode fiber) 0x0018: 1000BaseLX FD (Long wavelength fiber) 0x001A: 1000BaseSX FD (Short wavelength fiber) 0x001E: 1000BaseT FD (Copper)	Copper Ports: 0x001E = 1000T, FD SFP Ports: (Depends on SFP type) 0x0012 = 100 FX, LX 0x0018 = 1000 LX, FD 0x001A = 1000 SX, FD 0x001E = 1000 T, FD SC Fiber Ports: 0x0012 = 100 FX, FD

Management Address TLV

The Management Address is the address associated with the local LLDP agent that may be used to reach higher layers within the device to assist with LLDP operations. Typically, this indicates how to reach the LLDP MIB. The Management Address TLV contains three fields: Management Address, Interface Number, and Object Identifier (OID).

Management Address

The Management Address indicates the management address of this device. For the RX3i PROFINET Controller, the management address is the IP Address of the device.

Subtype	Meaning	Address Value
4	IPv4 address	IPv4 address of this device

Interface Number

The Interface Number identifies a specific interface or port at the specified management address. Thus, the interface number varies with the network port number. The RX3i Controller uses the current network port number.

Subtype	Meaning	Address Value
3	System port number	Management port number (1-max network ports)

Object Identifier (OID)

The OID specifies an MIB object (typically the LLDP MIB) in ASN.1 format that is reachable at the specified management address and interface number. A length of zero means that an OID is not provided. The OID value is internally assigned by, and meaningful only to, the LLDP device.

Appendix A: PROFINET IO Performance Examples

Note: *The configurations and performance numbers shown here are examples; actual performance timings will vary depending on your exact configuration and network setup.*

This section presents various PROFINET IO systems and their measured I/O performance for a simple Discrete IO loopback in an RX3i IO Device and in a VersaMax IO-Device. As these systems are not identical in their configuration or setup, additional details of each system configuration are provided in the sections below.

The IO Loopback measurements were done by wiring the outputs of a discrete output module directly to the inputs of a discrete input module and using Ladder Logic to measure the time difference between setting the outputs and reading the same data on the corresponding inputs. PAC Machine Edition was attached to the RX3i during testing. The average, minimum, and maximum loopback times were captured from a 4-hour sample period. In addition, since the CPU sweep time is a primary factor in the accuracy and precision of the IO Loopback times recorded, the average and maximum CPU sweep times for each system are given.

Note: *CPU Sweep time variations between systems are not completely a function of varying PROFINET IO. It was also influenced by variations in logic executed and main rack configurations.*

A-1 Systems with RX3i PNS

RX3i System Performance Summary

System Configuration	Total # of PROFINET I/O Devices/Modules ²³	Total Amount PROFINET I/O Discrete pts./ Analog Chan.	RX3i CPU Sweep Time (ms) Average (Max)	16-pt. Discrete I/O Loopback Time (ms) Average (Min, Max)
1 ms PROFINET Update Rate				
A.2.1 - Multi-Device w/MRP	8/33 x 12-slot racks	176/16	4.1 (6.7)	12 (7, 20)
16 ms PROFINET Update Rate				
B.1 - Multi-Device	20/59 x 12-slot racks	656/64	6.0 (7.6)	28 (11, 48)

A-1.1 RX3i System Descriptions

Multi-Device with MRP (3i PNS)

This system contained an IC695CPU320, IC695ETM001, and an IC695PNC001 in the main rack. The PNC001 was connected in a Media Redundancy Protocol (MRP) network of eight RX3i PNS modules (IC695PNS001), each configured for a 1 ms PROFINET update rate. Each PNS contained between one and nine discrete input, discrete output, analog input, or analog output modules. The I/O Loopback measurement was taken using a 32-point output module (IC693MDL740) owned by one RX3i PNS that was then tied to the 32-point input module (IC694MDL660) in the same device. The input module (IC693MDL660) was set to have a 0.5 ms input filter time.

Multi-Device

This system contained an IC695CPU320, IC695ETM001, and an IC695PNC001 in the main rack. The PNC001 was connected in a network bus configuration to 20 RX3i PNS modules (IC695PNS001), each configured for a 16 ms PROFINET update rate. Each PNS contained at least two discrete input, discrete output, analog input, or analog output modules. The I/O Loopback measurement was taken using a 32-point output module (IC694MDL754) owned by one RX3i PNS, that was then tied to the 32-point input module (IC694MDL660) owned by a different RX3i PNS. The input module (IC694MDL660) was set to have a 0.5 ms input filter time.

A-2 Systems with VersaMax PNS

A-2.1 VersaMax System Performance Summary

²³ Number of modules includes I/O modules only; does not include head-ends or power-supplies.

System Configuration	Total # PROFINET I/O Devices/Modules ²³	Total Amount PROFINET I/O Discrete pts./Analog Chan.	RX3i CPU Sweep Time (ms) Average (Max)	16 pt. Discrete I/O Loopback Time (ms) Average (Min, Max)
1 ms PROFINET Update Rate				
A.1 – Single Device	1/4	192/0	3.2 (5.8)	8 (5, 13)
A.2 – Multi-Device	8/14	824/0	4.0 (6.4)	7 (4, 12)
A.2.1 – Multi-Device w/MRP	8/14	824/0	4.0 (6.6)	7 (4, 12)
A.3 – Multi-PNC001 Multi-Device	32/41	2808/85	7.2 (9.6)	14 (6, 17)
16 ms PROFINET Update Rate				
B.1 – Multi-Device	20/29	1928/0	5.2 (8.2)	22 (5, 42)
B.1.1 – Multi-Device w/MRP	20/29	1928/0	5.2 (7.7)	23 (5, 43)
B.2 – Max Device	64/89	5176/445	12.3 (15.4)	36 (11, 60)

A-2.2 VersaMax System Descriptions

1ms PROFINET Update Rate Systems

Single Device

This system contained an IC695CPU315, IC695ETM001, and an IC695PNC001 in the main RX3i rack. The PNC001 was connected to a single VersaMax PNS (IC200PNS001) configured for a 1 ms PROFINET update rate. The PNS contained four mixed discrete 16 point in/out modules (IC200MDD844). Each I/O module had its outputs tied to the inputs of an adjoining I/O module, and each input module was configured with a 1 ms Input DC Filter time. The I/O Loopback measurement was taken using one of the IC200MDD844 modules.

Multi-Device

This system contained an IC695CPU315, IC695ETM001, and an IC695PNC001 in the main RX3i rack. The PNC001 was connected in a network bus configuration to eight different VersaMax PNS modules (IC200PNS001), each configured for a 1ms PROFINET update rate. Each PNS contained at least one discrete input or output module. The I/O Loopback measurement was taken using a 16-point output module (IC200MDL741) owned by one VersaMax PNS, that was then tied to the 16-point input module (IC200MDL640) owned by a different VersaMax PNS. The input module (IC200MDL640) was configured for a 0 ms Input DC Filter time.

Multi-Device with MRP

This system is identical to the A.2 – Multi-Device configuration, except that Media Redundancy Protocol (MRP) was in use. To exercise MRP, the network was set up in a ring configuration and the PNC001 was configured as an MRP Manager with a configured Default Test Interval of 20ms.

Multi-PNC001 Multi-Device

This system contained an IC695CPU315, two IC695ETM001's, an IC694MDL732, an IC694MDL645, and four IC695PNC001 modules in the main rack. Each PNC001 module was connected in a network bus configuration to eight VersaMax PNS modules (IC200PNC001), each configured for a 1ms PROFINET update rate. Each PNS contained at least one discrete input, discrete output, analog input, or analog output module. The I/O Loopback measurement was taken using a 16-point output module (IC200MDL741) owned by one VersaMax PNS, that was then tied to the 16-point input module (IC200MDL640) owned by a different VersaMax PNS. The input module (IC200MDL640) was configured for a 1 ms Input DC Filter time.

16ms PROFINET Update Rate Systems

Multi-Device

This system contained an IC695CPU315, IC695ETM001, and an IC695PNC001 in the main rack. The PNC001 module was connected in a network bus configuration to 20 VersaMax PNS modules (IC200PNS001), each configured for a 16ms PROFINET update rate. Each PNS contained at least one discrete input, discrete output, analog input, or analog output module. The I/O Loopback measurement was taken using a 16-point output module (IC200MDL741) owned by one VersaMax PNS, that was then tied to the 16-point input module (IC200MDL640) owned by a different VersaMax PNS. The input module (IC200MDL640) was configured for a 0 ms Input DC Filter time.

Multi-Device with MRP

This system is identical to the B.1 – Multi-Device configuration, except that Media Redundancy Protocol (MRP) was in use. To exercise MRP, the network was set up in a ring configuration and the PNC001 module was configured as an MRP Manager with a configured Default Test Interval of 20ms.

Sixty-four IO-Device

This system contained an IC695CPU315, IC695ETM001, and an IC695PNC001 in the main rack. The PNC001 module was connected in a network bus configuration to 64 VersaMax PNS modules (IC200PNS001), each configured for a 16ms PROFINET update rate. Each PNS contained at least one discrete input, discrete output, analog input, or analog output module. The I/O Loopback measurement was taken using a 16-point output module (IC200MDL741) owned by one VersaMax PNS, that was then tied to the 16-point input module (IC200MDL640) owned by a different VersaMax PNS. The input module (IC200MDL640) was configured for a 1 ms Input DC Filter time.

A-3 Systems with RSTi-EP EPSCPE100/CPE115

A-3.1 RSTi-EP CPE100/CPE115 Embedded PROFINET Controller System Performance Summary

System Configuration	Total # of PROFINET I/O Devices/ Modules ²⁴	Total Amount PROFINET I/O Discrete pts./ Analog Chan.	RSTi-EP CPU Sweep Time (ms) Average (Max)	8-pt. Discrete I/O Loopback Time (ms) Average (Min, Max)	4-pt. Analog I/O Loopback Time (ms) Average (Min, Max)

²⁴ Number of modules includes I/O modules only; does not include head-ends or power-supplies.

16 ms PROFINET Update Rate					
Single Device	1/10	8/44	2.7 (7.17)	25 (11,41)	24 (11,40)
Single Device Max-IO	1/64	188/148	6.9 (13.8)	36 (17, 56)	33 (11, 48)
Max-Device	8/96	428/225	11.4 (18.7)	48 (20, 69)	40 (18, 57)
Device with Ethernet Protocols	4/70	348/173	16.8(26.7)	48(15, 77)	39 (12, 61)

A-3.2 RSTi-EP System Descriptions

16ms PROFINET Update Rate Systems

Single Device

This system contained an RSTi-EP Standalone Controller with embedded PROFINET EPSCPE100/CPE115 and IO Scan in Normal Sweep mode. The embedded Ethernet is connected to PAC Machine Edition. The embedded PROFINET Controller CPE100/CPE115 was connected to a single RSTi-EP PNS (EPXPNS001) configured for a 16ms PROFINET update rate. The PNS contained 10 I/O modules with combinations of discrete 4 point in/out modules & analog 4/6 channel in/out modules. Each I/O module had its outputs tied to the inputs of an adjoining I/O module. The total data Bytes size is 122. The I/O Loopback measurement was taken using EP-2214 (DO4) & EP-1214 (DI4) discrete modules and EP-3124 (AI4 V/I 12BITS) & EP-4264 (AO4 V/I DIAG) analog modules.

Single Device Max-IO

This system contained an RSTi-EP Standalone Controller with embedded PROFINET EPSCPE100/CPE115 and IO Scan in Normal Sweep mode. The embedded Ethernet is connected to PAC MACHINE EDITION. The embedded PROFINET Controller CPE100/CPE115 was connected to a single RSTi-EP PNS (EPXPNS001) configured for a 16 ms PROFINET update rate. The PNS contained 64 I/O modules with various combinations of discrete 4/8/16 point in/out modules & analog 4/8 channel in/out modules. Each I/O module had its outputs tied to the inputs of an adjoining I/O module. The total data Bytes size is 713. The I/O Loopback measurement was taken using EP-2218 (DO8) & EP-1218 (DI8 2-wire) discrete modules and EP-3124 (AI4 V/I 12BITS) & EP-4264 (AO4 V/I DIAG) analog modules.

Max-Device

This system contained an RSTi-EP Standalone Controller with embedded PROFINET EPSCPE100/CPE115 and IO Scan in Normal Sweep mode. The embedded Ethernet is connected to PAC MACHINE EDITION. The embedded PROFINET Controller CPE100/CPE115 was connected in a network bus configuration to eight different PNS modules (4 - EPXPNS001, 1 - RX3i CEP001, 1 - RX3i PNS001, and 2 - VersaMax PNS001), each configured for a 16ms PROFINET update rate. All the devices contained 96 I/O modules with various combinations of discrete 4/8/16 point in/out modules & analog 4/8 channel in/out modules. Each I/O module had its outputs tied to the inputs of an adjoining I/O module. The total data Bytes size is 1262. The I/O Loopback measurement was taken on device EPXPNS001 using EP-2218 (DO8) & EP-1218 (DI8

2-wire) discrete modules and EP-3124 (AI4 V/I 12BITS) & EP-4264 (AO4 V/I DIAG) analog modules.

Device with Ethernet Protocols

This system contained an RSTi-EP Standalone Controller with embedded PROFINET EPSCPE100/CPE115 and IO Scan in Normal Sweep mode. The embedded Ethernet LAN1 port was configured with 2 Modbus Client channels with 200 data Bytes, 2 Modbus Server channels with 150 data Bytes, 2 SRTP Client channels with 256 data Bytes, 2 SRTP Server channels with 50 data Bytes, 2 EGD Producers with 800 data Bytes at 100ms production rate each, 2 EGD Consumers, and connected to PAC MACHINE EDITION. The embedded PROFINET Controller LAN2 port was connected in a network bus configuration to four different PNS modules (EPXPNS001, RX3i CEP001, RX3i PNS001, and VersaMax PNS001), each configured for a 16ms PROFINET update rate. All the devices contained 70 I/O modules with various combinations of discrete 4/8/16 point in/out modules & analog 4/8 channel in/out modules. Each I/O module had its outputs tied to the inputs of an adjoining I/O module. The total PROFINET data Bytes size is 831. The I/O Loopback measurement was taken on device EPXPNS001 using EP-2218 (DO8) & EP-1218 (DI8 2-wire) discrete modules and EP-3124 (AI4 V/I 12BITS) & EP-4264 (AO4 V/I DIAG) analog modules.

A-4 Systems with RSTi-EP CPE200 Series

A-4.1 RSTi-EP CPE200 Series Embedded PROFINET Controller System Performance Summary

System Configuration	Total # of Local I/O Modules	Total # of PROFINET I/O Devices/ Modules	Total Amount PROFINET I/O Discrete pts./ Analog Chan	RSTi-EP CPU Sweep Time (ms) Average (Max)	16-pt. Discrete I/O Loopback Time (ms) Average (Max)	8-pt. Analog I/O Loopback Time (ms) Average (Max)
1 ms PROFINET Update Rate						
Multi-Devices w/ MRP	0	2/4	64/0	1(3)	11(15)	N/A
Multi-Devices	0	2/4	64/0	1(3)	11(15)	N/A
16 ms PROFINET Update Rate						
Multi-Devices w/ MRP	0	31/55	1072/215	8(9)	38(52)	34(164)
Multi-Devices	0	32/56	1104/215	8(10)	37(53)	36(167)
32 ms PROFINET Update Rate						
Multi-Devices w/ MRP	0	31/55	1072/215	8(10)	54(86)	54(198)
Multi-Devices	0	32/56	1104/215	8(10)	54(88)	54(199)

System Configuration	Total # of Local I/O Modules	Total # of PROFINET I/O Devices/ Modules	Total Amount PROFINET I/O Discrete pts./ Analog Chan	RSTi-EP CPU Sweep Time (ms) Average (Max)	16-pt. Discrete I/O Loopback Time (ms) Average (Max)	8-pt. Analog I/O Loopback Time (ms) Average (Max)
32 ms PROFINET Update Rate and Ethernet Protocols (Max Connections)						
Multi-Devices w/ MRP	4	31/55	1072/215	29(33)	78(317)	85(371)
32ms PROFINET Update Rate Systems with Max Local IO, Serial COM and Ethernet Protocols (Max Connections)						
Multi-Devices w/ MRP	64	31/156	1164/545	42(51)	138(210)	94(178)

A-4.2 RSTi-EP CPE200 Series System Descriptions

1ms PROFINET Update Rate Systems

Multi Device / Multi-Device with MRP

This system contained an RSTi-EP Controller with embedded PROFINET EPXCPE240 and IO Scan in Normal Sweep mode. The embedded Ethernet is connected to PAC Machine Edition The embedded PROFINET Controller CPE240 was connected to a two CEP001 PNS configured for a 1ms PROFINET update rate (with/without MRP). The PNS contained 2 I/O modules each with combinations of discrete 16 point in/out modules. Each I/O module had its outputs tied to the inputs of an adjoining I/O module. The total data Bytes size is 52. The I/O Loopback measurement was taken using IC694MDL740(DO16) & IC694MDL645 (DI16) discrete modules.

16ms / 32ms PROFINET Update Rate Systems

Multi Device

This system contained an RSTi-EP Controller with embedded PROFINET EPXCPE240 and IO Scan in Normal Sweep mode. The embedded Ethernet is connected to PAC MACHINE EDITION. The embedded PROFINET Controller CPE240 was connected to 32 PNS configured for a 16/32ms PROFINET update rate. The PNS contained I/O modules with various combinations of discrete 16/32 point in/out modules & analog 4/8 channel in/out modules. Each I/O module had its outputs tied to the inputs of an adjoining I/O module. The total data Bytes size is 1484. The I/O Loopback measurement was taken using IC694MDL740(DO16) & IC694MDL645 (DI16) discrete modules and IC695ALG708(AO8) & IC694ALG600 (AI8) analog modules.

Multi-Device with MRP

This system contained an RSTi-EP Controller with embedded PROFINET EPXCPE240 and IO Scan in Normal Sweep mode. The embedded Ethernet is connected to PAC MACHINE EDITION. The embedded PROFINET Controller CPE240 was connected to 31 PNS configured for a 16/32ms PROFINET update rate with MRP. The PNS contained I/O modules with various combinations of discrete 16/32 point in/out modules & analog 4/8 channel in/out modules. Each I/O module had its outputs tied to the inputs of an adjoining I/O module. The total data Bytes size is 1456. The I/O Loopback measurement was taken using IC694MDL740(DO16) & IC694MDL645 (DI16) discrete modules and IC695ALG708(AO8) & IC694ALG600 (AI8) analog modules.

32ms PROFINET Update Rate Systems with Ethernet Protocols (Maximum connections)

Multi-Device with MRP

This system contained an RSTi-EP Controller with embedded PROFINET EPXCPE240 and IO Scan in Normal Sweep mode. The embedded Ethernet is connected to PAC MACHINE EDITION. The embedded PROFINET Controller CPE240 was connected to 31 PNS configured for a 32ms PROFINET update rate with MRP. The PNS contained I/O modules with various combinations of discrete 16/32 point in/out modules & analog 4/8 channel in/out modules. Each I/O module had its outputs tied to the inputs of an adjoining I/O module. The total data Bytes size is 1456. The I/O Loopback measurement was taken using IC694MDL740(DO16) & IC694MDL645 (DI16) discrete modules and IC695ALG708(AO8) & IC694ALG600 (AI8) analog modules. The PROFINET interface also configured with 16 Modbus Server with 246 bytes each, 16 Modbus Client channels with 246 Bytes each, 8 SRTP Client channels with 1024 Bytes each, 31 SRTP Server channels with 1024 Bytes each, 16 EGD Producers with 1400 data Bytes at 100ms production rate each, 16 EGD Consumers with 1400 data Bytes, OPCUA and DNP3 8 clients. The controller also has 4 local IO's with combination of discrete 16 point in/out modules & analog 4 channel in/out modules.

32ms PROFINET Update Rate Systems with Max Local IO, Serial COM and Ethernet Protocols (Max Connections)

Multi-Device with MRP

This system contained an RSTi-EP Controller with embedded PROFINET EPXCPE240 and IO Scan in Normal Sweep mode. The embedded Ethernet is connected to PAC MACHINE EDITION. The embedded PROFINET Controller CPE240 was connected to 31 PNS configured for a 32ms PROFINET update rate with MRP. The PNS contained I/O modules with various combinations of discrete 4/8/16/32 point in/out modules & analog 4/8 channel in/out modules. The Device1: RSTi-EP PNS (EPSPNS001) device contains 64 IO modules (maximum). Each I/O module had its outputs tied to the inputs of an adjoining I/O module. The total data Bytes size is 2192. The I/O Loopback measurement was taken on Device1 using EP-225F(DO16) & EP-125F(DI16) discrete modules and EP-4164 (AO4), EP-4164 (AO4) & EP-3368 (AI8) analog modules. The PROFINET interface also configured with 16 Modbus Server with 246 bytes each, 16 Modbus Client channels with 246 Bytes each, 8 SRTP Client channels with 1024 Bytes each, 30 SRTP Server channels with 1024 Bytes each, 16 EGD Producers with 1400 data Bytes at 100ms production rate each, 16 EGD Consumers with 1400 data Bytes, OPCUA and DNP3 8 clients. The controller also has 64 local IO's with combination of discrete 4/8/16 point in/out modules & analog 4/8 channel in/out modules. Controller is also configured with serial RTU.

General Contact Information

Home link: <http://www.emerson.com/industrial-automation-controls>

Knowledge Base: <https://www.emerson.com/iac-support>

Technical Support

Americas

Phone: 1-888-565-4155
1-434-214-8532 (If toll-free option is unavailable)

Customer Care (Quotes/Orders>Returns): customercare.mas@emerson.com
Technical Support: support.mas@emerson.com

Europe

Phone: +800-4444-8001
+420-225-379-328 (If toll-free option is unavailable)
+39-0362-228-5555 (from Italy - if toll-free 800 option is unavailable or dialing from a mobile telephone)

Customer Care (Quotes/Orders>Returns): customercare.emea.mas@emerson.com
Technical Support: support.mas.emea@emerson.com

Asia

Phone: +86-400-842-8599
+65-3157-9591 (All other Countries)

Customer Care (Quotes/Orders>Returns): customercare.cn.mas@emerson.com
Technical Support: support.mas.apac@emerson.com

Any escalation request should be sent to: mas.sfdcescalation@emerson.com

Note: If the product is purchased through an Authorized Channel Partner, please contact the seller directly for any support.

Emerson reserves the right to modify or improve the designs or specifications of the products mentioned in this manual at any time without notice. Emerson does not assume responsibility for the selection, use or maintenance of any product. Responsibility for proper selection, use and maintenance of any Emerson product remains solely with the purchaser.

© 2024 Emerson. All rights reserved.

Emerson Terms and Conditions of Sale are available upon request. The Emerson logo is a trademark and service mark of Emerson Electric Co. All other marks are the property of their respective owners.

